

Wood Industry Belts for Board and Panel Manufacturing

Habasit – Solutions in motion



Contents

Solutions for the wood industry	3
Panel board manufacturing	4
Portfolio, features and benefits	
• HabaFLOW® fabric-based conveyor belts	5
• HabaDRIVE® power transmission belts	7
Application table	8
Services	10
The Habasit solution	11
Habasit worldwide	12

This **disclaimer** is made by and on behalf of Habasit and its affiliated companies, directors, employees, agents and contractors (hereinafter collectively "HABASIT") with respect to the products referred to herein (the "Products"). SAFETY WARNINGS SHOULD BE READ CAREFULLY AND ANY RECOMMENDED SAFETY PRECAUTIONS FOLLOWED STRICTLY! Please refer to the Safety Warnings herein, in the Habasit catalogue as well as installation and operating manuals.

All indications / information as to the application, use and performance of the Products are recommendations provided with due diligence and care, but no representations or warranties of any kind are made as to their completeness, accuracy or suitability for a particular purpose. The data provided herein are based on laboratory application with small-scale test equipment, running at standard conditions, and do not necessarily match product performance in industrial use. New knowledge and experience may lead to re-assessments and modifications within a short period of time and without prior notice.

EXCEPT AS EXPLICITLY WARRANTED BY HABASIT, WHICH WARRANTIES ARE EXCLUSIVE AND IN LIEU OF ALL OTHER WARRANTIES, EXPRESS OR IMPLIED, THE PRODUCTS ARE PROVIDED "AS IS". HABASIT DISCLAIMS ALL OTHER WARRANTIES, EITHER EXPRESS OR IMPLIED, INCLUDING, BUT NOT LIMITED TO, IMPLIED WARRANTIES OF MERCHANTABILITY, FITNESS FOR A PARTICULAR PURPOSE, NON-INFRINGEMENT, OR ARISING FROM A COURSE OF DEALING, USAGE, OR TRADE PRACTICE, ALL OF WHICH ARE HEREBY EXCLUDED TO THE EXTENT ALLOWED BY APPLICABLE LAW. BECAUSE CONDITIONS OF USE IN INDUSTRIAL APPLICATION ARE OUTSIDE OF HABASIT'S CONTROL, HABASIT DOES NOT ASSUME ANY LIABILITY CONCERNING THE SUITABILITY AND PROCESS ABILITY OF THE PRODUCTS, INCLUDING INDICATIONS ON PROCESS RESULTS AND OUTPUT.



Solution provider for the wood industry

Wood processing machines require a wide range of industrial belting. Habasit has developed an adapted range of solutions in power transmission, conveyor and processing belts.

This is why Habasit is able to offer the most suitable belt for every application, from solid wood processing to industrial furniture manufacturing up to production lines of all kinds for engineered wood products such as particle board, MDF/HDF, OSB, plywood and LVL.

Thanks to close co-operation with leading machine manufacturers, suppliers and industry specialists, Habasit has developed and provides a specialized, customer-oriented application range of products and fabrication technology. These are backed by skilled consulting in all areas of wood-based panel manufacturing.

Are you looking for reliable and long-lasting belts with an excellent price-to-value ratio for your wood composite board production line? Habasit products are renowned in the market for their excellent quality and high reliability. They are recommended by leading manufacturers worldwide.

Without any doubt, this fact has a lot to do with the confidence these companies have in Habasit's ability to deliver high quality and competitively priced replacement belts on time anywhere in the world. Habasit fully meets their expectations, and this is confirmed by our outstanding market position in the OEM (Original Equipment Manufacturer) and EU (End User) business.

Innovation is a key word at Habasit

Continuous development has led to an extensive variety of solutions, from fabric-based conveyor and processing belts to HabasitLINK® plastic modular belts and HabaSYNC® timing belts, enabling our customers to choose the best possible product for their application.

Competence and experience

Habasit application engineers, technicians and joining specialists are at your disposal to provide you with professional consulting, superb customer service and excellent support. With decades of experience, since its foundation in 1946, Habasit has proved that it understands customers' needs. Thanks to its comprehensive global network, Habasit is able to respond to any request that you may have, with nothing less than an outstanding belting solution of top quality tailored to your specific needs.



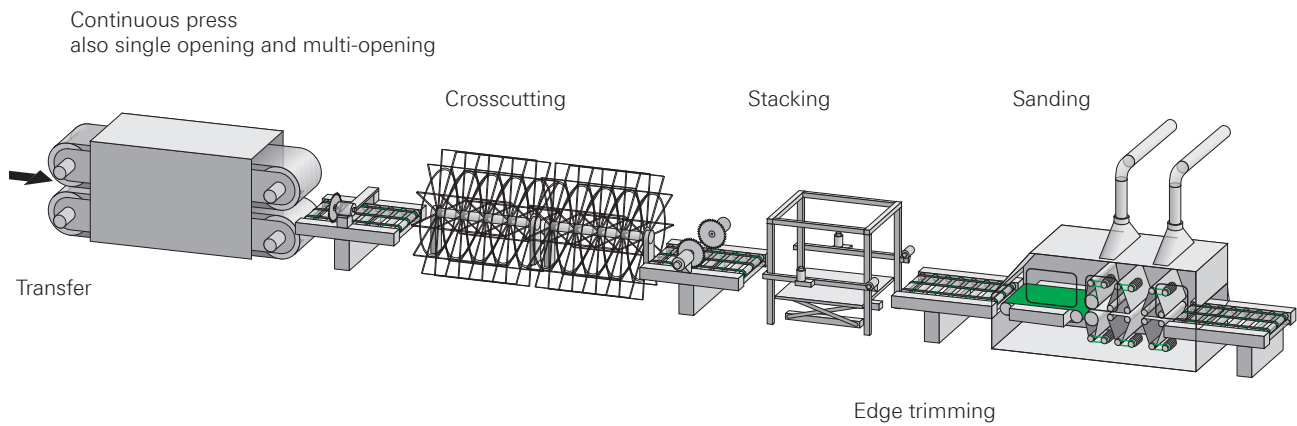
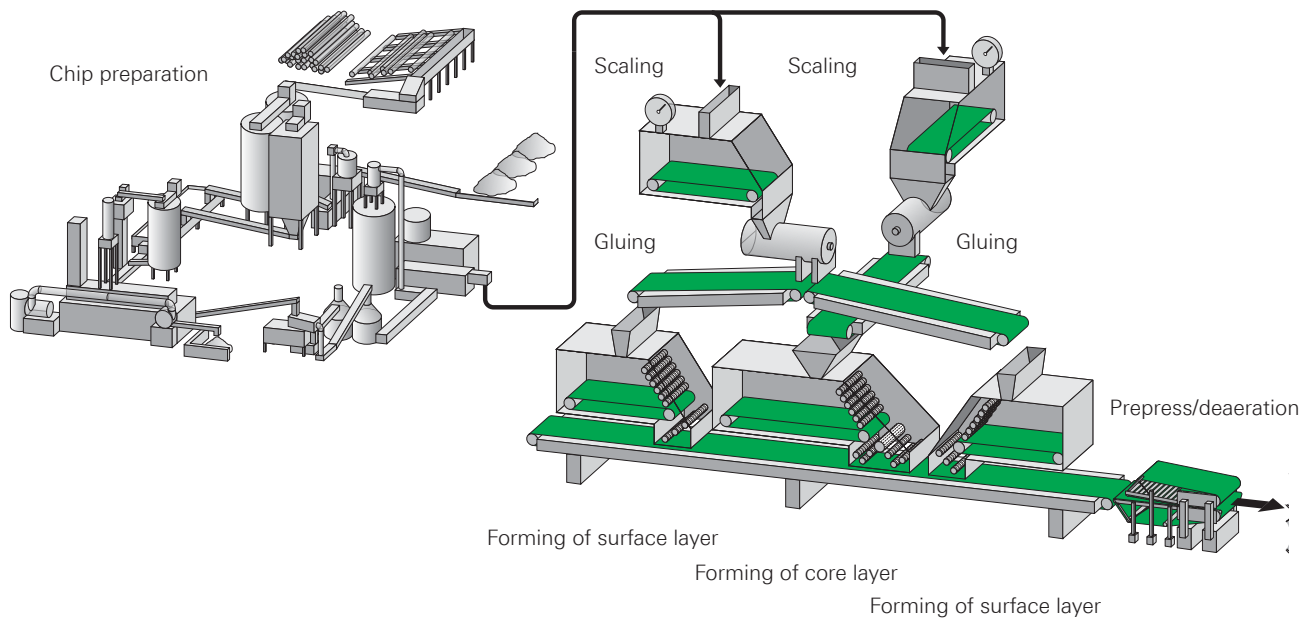

The drawing shows schematic examples of selected applications and processes, and are neither complete nor comprehensive. The belt recommendations (use/application/layout) can only be considered as a general suggestion. Due to the complexity of the various processes and technical requirements, and external influences such as the nature or properties of the transported goods, process speeds, stages of treatment/handling, environmental or process temperatures, humidity, chemicals, additives, ingredients, and recipes, etc. there are many possible solutions.



The right belt for every application

Habasit's conveyor belt selection includes hundreds of different belts to satisfy application requirements that range from straight-inclined or declined operations, to accumulation and diverters, to swan neck (Z) conveyors, and numerous others. We offer a wide variety of tension members and cover materials, as well as structural conveying- and running-side patterns to optimize your system's performance.

Belt materials

The materials and designs are selected to cope with a broad range of application requirements, including resistance to wear or chemical agents, and to high or low temperatures. Furthermore, our belts maintain excellent stress-strain behavior through the use of carefully selected tension members.

Belt design

Habasit conveyor and processing belts are generally made of different layers, with tensile strength provided by synthetic fabric plies. These fabrics are connected by layers of thermoplastic materials. The material, thickness and texture of the conveying side depend on the function of the belt.

Cover coatings are mainly made of thermoplastic materials like TPU, TPO, PVC, etc., and elastomer-like rubbers, PUR, etc. – or feature a fabric cover. The running side is usually a fabric, often impregnated with a thermoplastic material, or with special wear-resistant PUR that provides a low and constant coefficient of friction. There are also pulley-side fabrics that feature special low-noise running capabilities.

Attachments and profiles

Guides, cleats and side walls are the most common modifications applied to conveyor and processing belts. While V-shaped profiles are mostly attached to the running side as guides, various cleat designs can be welded or bonded to the conveying side to ensure proper transport either horizontally or on an incline. Side walls positioned close to the edges of the belt stop loose goods falling off.

Surface structure

A well-designed belt surface supports both the secure transport of the goods conveyed as well as the process where the belt is employed. Careful selection is essential in order to find the right belt for each conveying or processing application. The belt surface plays a key role in meeting each specific process step or function.

Selection of surface structures



Blank, smooth

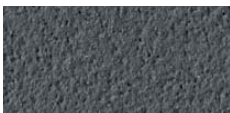

Super matt finish (sand finish)

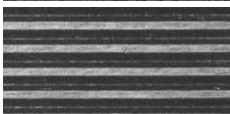

Longitudinal groove structure



Jink wave (sine wave) grip structure



Grip (rough top) structure



Quadrille (quadrangular pattern) structure

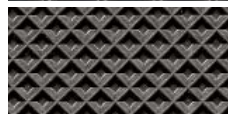

Waffle structure



Nonwoven (fleece, buffed or ground finish) structure

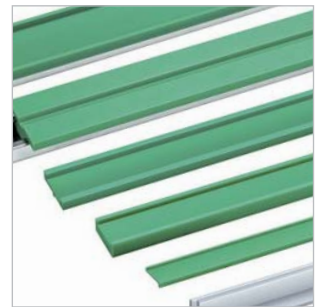
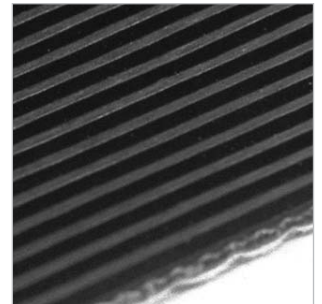

TPU forming belts

The Habasit Extraline forming, transfer or accelerator belts have been specifically developed to cope with the requirements of all the belt applications of the forming process. These processing belts are designed to run over live nosebars with high loads and long conveying distances. Their excellent stability and thickness precision over length and width enable manufacturing of every kind of boards as well as very thin boards. The suitability for the use with highly sensitive metal detectors allows to protect the very expensive production equipment.



Key features	Your benefits
<ul style="list-style-type: none"> • Longitudinal flexibility • Transversal rigidity 	<ul style="list-style-type: none"> → Suitable for live nosebars at high tensile force → Constant running speed with high load over very long distances → Excellent tracking properties → High production reliability
<ul style="list-style-type: none"> • High chemical and abrasion resistance • High hydrolysis resistance 	<ul style="list-style-type: none"> → No alteration of belt surface → Maintenance-free = long belt life → No sticking/accumulating on the belt
<ul style="list-style-type: none"> • Permanently antistatic 	<ul style="list-style-type: none"> → No generation of sparks → No interference with electronic controls → No dust or dirt attraction

TPU prepress belts

The perfect prepressing of the mat is made possible thanks to the high modulus of elasticity, obtained with the use of both aramide and polyester fabrics, combined with the excellent pressure resistance and compression distribution of the Habasit Extraline prepress belts.



Key features	Your benefits
<ul style="list-style-type: none"> • High chemical and abrasion resistance • Homogeneous belt surface 	<ul style="list-style-type: none"> → No alteration of belt surface → Maintenance-free → Long belt life
<ul style="list-style-type: none"> • Essential pressure resistance 	<ul style="list-style-type: none"> → Regular pressing of the chip cake → High quality processing and productivity
<ul style="list-style-type: none"> • High modulus of elasticity 	<ul style="list-style-type: none"> → No retensioning → Maintenance-free operation

PET deaeration belts

The Habasit Extraline deaeration belts for both MDF and particleboard manufacturing are the key to an increased productivity thanks to their high and controlled air flow rates. Their robust construction based on polyester monofilament provides a high chemical and abrasion resistance for a long and maintenance-free belt life.



Key features	Your benefits
<ul style="list-style-type: none"> • High airflow rate 	<ul style="list-style-type: none"> → Excellent deaeration process → Increased line speed
<ul style="list-style-type: none"> • Permanently antistatic 	<ul style="list-style-type: none"> → No generation of sparks → No interference with electronic controls → No dust or dirt attraction
<ul style="list-style-type: none"> • Flexproof joining on site • Double loop seam joining 	<ul style="list-style-type: none"> → Easy handling and short downtimes → High flexibility and strenght → Keeps air permeability over the joining area

Customized solutions every time

Habasit power transmission belts are tailor-made to suit specific industry and application needs or machine designs. We offer three different traction layer materials, used by three different belt concepts, for open drive, tangential drive, multiple pulley drive, live roller drive, and double-sided power transmission.

Polyamide power transmission belts (PA)

Polyamide power transmission belts are resilient. They can cope with rough working conditions and have an extremely long service life during which they guarantee consistently high power transmission.

Asymmetrically built: A-series *Symmetrically built:* S- and SP-series

Polyester power transmission belts (PET)

Habasit developed this unique product range through our close contacts with leading machine manufacturers worldwide, and ongoing research. The result is an energy-saving product range with a perfect price/value ratio.

Asymmetrically built: TCF-series *Symmetrically built:* TC-, and CM-series

Aramide power transmission belts (AR)

TF tangential/flat belts are used for extremely compact driving configurations and for very long belts with high working speeds. Aramide power transmission belts provide high efficiency, energy-saving features, and high power transmission. They run at a very low initial working tension with little noise and have outstanding dimensional stability.

Asymmetrically built: TF-series *Symmetrically built:* TF-series

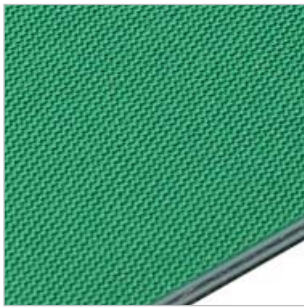

Key features	PA	PET	AR	Your benefits
<ul style="list-style-type: none"> • Low energy consumption 		●	●	<ul style="list-style-type: none"> → Energy and cost savings → Energy consumption reduced by 4% to 6% → Efficient production → Good price/value ratio
<ul style="list-style-type: none"> • TC range: high elastic modulus 		●		<ul style="list-style-type: none"> → High accuracy of machine speed
<ul style="list-style-type: none"> • TF range: top-grade elastic modulus 			●	<ul style="list-style-type: none"> → Highest accuracy of machine speed → Suitable for very long belts
<ul style="list-style-type: none"> • Forgiving, can cope with rough working conditions 	●			<ul style="list-style-type: none"> → Belt can handle intermittent overloads and robust → Process reliability → Long belt life
<ul style="list-style-type: none"> • Very flexible belt 		●	●	<ul style="list-style-type: none"> → Excellent flex-fatigue properties → Longest service life → Outstanding reliability → Suitable for small pulley diameters
<ul style="list-style-type: none"> • Stable modulus of elasticity after running-in • Good dimensional stability 	●	●	●	<ul style="list-style-type: none"> → No retensioning → No downtimes → No maintenance
<ul style="list-style-type: none"> • Adhesive-free joining method 		●	●	<ul style="list-style-type: none"> → Easy handling → Short machine downtimes → Minimum equipment required
<ul style="list-style-type: none"> • Two colors as installation aid 	●	●	●	<ul style="list-style-type: none"> → Easy insertion, no installation errors → No accidental twisting of the belt → Short machine downtimes

	HabaFLOW® fabric-based conveyor belts																		
	PVC coated									TPU coated					PUR coated				
	NAB-12EEAV	NAB-18EEAV 11	NAB-8EEDV 11	NAB-12EEDV 11	NAB-15EVDV	NAG-8EEDV 11	NAS-8EHDV	SNB-12E 07	SNB-18E 07	EMB-12EMCH*	EMB-20EMCH*	ENB-12ERCH*	F-5EXWT 05	F-8EXWT 05	F-8EQWT 05	FAB-5EIWH	ENA-151AEBH*	HNA-8P	HNA-18P
Wood fiber/flake preparation																			
Flaker/chipper/hammermill drives																			
(Wet/dry) bin belts	•	•	•	•				•											
Transfer line belts	•	•	•	•	•		•	•											
Scale belts				•								•			•				
Shuttle conveyors	•	•	•	•															
Bunker bottom belts		•						•	•		•								
Forming machine	•	•		•					•										
Forming line																			
Forming belts										•	•	•		•	•				
Prepress belts																	•		
Deaeration belts																			
Saw table belts	•			•				•											
Accelerator belts	•			•			•	•											
Transfer belts																•			
Tipple belts	•			•		•	•	•											
Preloader belts	•			•		•	•	•											
Tray loader belts																		•	•
Screen return belts							•												
Trash conveyor belts	•	•		•		•		•											
Board handling																			
Trimming	•	•	•	•				•											
Cross-cutting	•	•	•	•				•											
Sanding/calibrating																			
Board handling (live roller lines)																			

* Habasit declares those products as components which are intended for incorporation into **ATEX-compliant** equipment or assemblies. This components fulfil the classification: **Ex II 2 G IIB D c Ta ≤ +80°C**, qualified for equipment in potential explosive areas of zones 20, 21 and 22 as well as zone 1 and 2 with substance of explosion group IIA and/or IIB (typically mists of lacquering spraying cabinets, wood dust, sugar dust, etc); protection achieved by constructional safety; for maximum ambient temperature ≤ + 80°C.

Comprehensive services are central to Habasit’s belting solution approach.

As committed partners to our customers, we are dedicated to sharing our knowledge and to providing full support.



Comprehensive consulting and technical support

Habasit offers the best consulting and technical support on the belting market. Everything revolves around our customers: each affiliate has its own belting experts. The Habasit team is proud to provide the highest levels of support, together with top-quality products that have been leaders on the global market for decades.

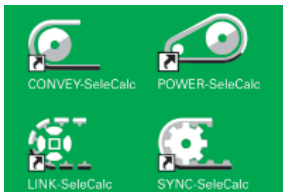

Assistance with belt selection and calculation

We will select and calculate the most suitable belt for your specific application. You can also do this yourself with our state-of-the-art Habasit selection and calculation program “SeleCalc”. To order this program free of charge, simply call your nearest Habasit partner or contact: info@habasit.com.



Fabrication, assembly and local installation services for quick reaction times

We make belts endless or assemble modular belts or chains, either at our own locations or on-site directly on your machine or system. Habasit operates over 30 affiliated companies worldwide, each with its own inventory, fabrication, assembly and service facilities. Together with our representative offices and numerous qualified distributors, we can react quickly, competently and reliably to satisfy all your demands.



Tools for on-site fabrication

Because we understand your processes, we can support you with cost-effective, high-quality tools that keep your equipment up and running. In case of emergency our tools will help to minimize breakdown time and support the joining process.



Habasit offers skivers to prepare the belt ends of polyamide power transmission belts and spindle tapes prior to joining. Finger cutting devices to prepare aramide and polyester power transmission belts and TPU spindle tapes are also available. A selection of hot pressing devices to fit your applications and guarantee optimum quality of joining complement the range.

Customer training programs

Habasit offers training programs and provides support tools to ensure optimal use of our products and to prolong their lifetimes. Training on fabrication, installation, assembly, maintenance and belt repair takes place at Habasit sites or at your location.



Belt monitoring, inspections, analyses and process optimization proposals

We organize and handle belt maintenance, inspections, analyses and surveys for your locations. On request we will also work with you to develop optimization proposals, for example, to achieve added value from your machinery or process output.



Design assistance for customized solutions

Habasit believes in partnership. Our engineering team will work closely with your engineers on joint design developments, preferably from a very early stage. We particularly recommend this for projects involving new technologies or large-scale modifications and adaptations.



Customers first

At Habasit we understand that our success depends on your success. This is why we offer solutions, not just products; partnership, not just sales.

Since our foundation in 1946, Habasit has brought this understanding of customer needs to life every day and for every application. That's why we're the No. 1 in belting today. Worldwide.

Learn more at www.habasit.com

Committed to innovation

Because our customers' belting challenges and needs never cease, we consistently dedicate a substantial percentage of our employees and resources to the research and development of new products and solutions.

Certified for quality

We deliver the highest quality standards not only in our products and solutions, but also in our employees' daily work processes. Habasit AG is certified according to ISO 9001:2008.



Worldwide leading product range

Habasit offers the largest selection of belting, conveying, processing and complementary products in the industry. Our response to any request is always a specific, tailor-made solution.

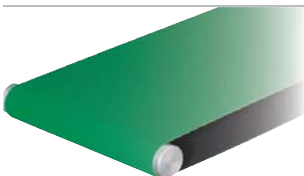

Fabric-based conveyor and processing belts
HabaFLOW®

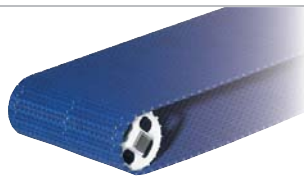

Plastic modular belts
HabasitLINK®

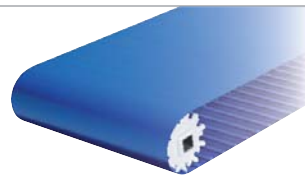

Positive drive conveyor and processing belts
Habasit Cleandrive™



Power transmission belts
HabaDRIVE®



Timing belts
HabaSYNC®



Chains (slat and conveyor chains)
HabaCHAIN®

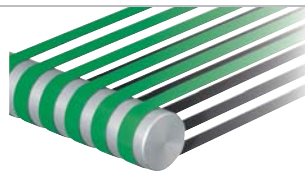

Machine tapes

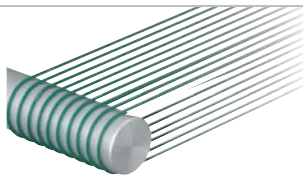

Round belts



Seamless belts

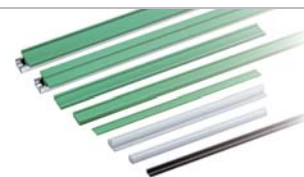

Profiles, Guides, Wear strips
HabiPLAST®



Fabrication tools (joining tools)



Gearmotors
Electric motors
Motion control

Australia

Habasit Pty Ltd.
Silverwater
Phone: +61 1300 945 455
www.habasit.com.au

Austria

Habasit GmbH
Wien
Phone: +43 1 690 66
www.habasit.at

Belgium

Habasit Belgium N.V.
Zaventem
Phone: +32 27 250 430
www.habasit.be
www.habasit.lu

Canada

Habasit Canada Ltd.
Oakville
Phone: +1 905 827 41 31
www.habasit.ca

China

Habasit East Asia Ltd.
Hong Kong
Phone: +85 221 450 150
www.habasit.com.hk

Habasit (Shanghai) Co. Ltd.
Shanghai
Phone: +8621 5488 1228
Phone: +8621 5488 1218
www.habasit.com.hk

France

Habasit France S.A.S.
Mulhouse
Phone: +33 389 338 903
www.habasit.fr

Germany

Habasit GmbH
Eppertshausen
Phone: +49 6071 969 0
www.habasit.de

India

Habasit-lakoka Pvt. Ltd.
Coimbatore
Phone: +91 422 262 78 79
www.habasitlakoka.com

Italy

Habasit Italiana SpA
Customer Care:
Phone: 199 199 333
For int. calls: +39 0438 911 444
www.habasit.it

Japan

Habasit Nippon Co. Ltd.
Yokohama
Phone: +81 45 476 0371
www.habasit.co.jp

Netherlands

Habasit Netherlands BV
Nijkerk
Phone: +31 332 472 030
www.habasit.nl

New Zealand

Habasit Ltd.
Auckland
Phone: 0800 000 070
www.habasit.co.nz

Poland

Habasit Polska Sp. z o.o.
Dąbrowa Górnicza
Phone: +48 32 639 02 40
www.habasit.pl

Russia

OOO Habasit Ltd.
St. Petersburg
Phone: +7 812 600 40 80
www.habasit.ru

Singapore

Habasit Far East Pte. Ltd.
Singapore
Phone: +65 686 255 66
www.habasit.com.sg

South Africa

Habasit South Africa (Pty) Ltd.
Gauteng
Phone: +27 12 664 2630
www.habasit.co.za

Spain

Habasit Hispanica S.A.
Barberà del Vallès
Phone: +34 937 191 912
www.habasit.es

Sweden

Habasit AB
Hindas
Phone: +46 30 122 600
www.habasit.se

Switzerland

Habasit GmbH
Reinach
Phone: +41 61 577 51 00
www.habasit.ch

Taiwan

Habasit (Taiwan) Ltd.
Taipei Hsien
Phone: +886 2 2267 0538
www.habasit.com.tw

Turkey

Habasit Kayis San. Ve Tic. Ltd. Sti.
Yenibosna-Bahcelievler-Istanbul
Phone: +90 444 70 43
www.habasit.com.tr

Ukraine

Habasit Ukraine LLC.
Vinnitsa
Phone: +38 0432 58 47 35
www.habasit.ua

United Kingdom and Ireland

Habasit (UK) Ltd.
Silsden
Phone: +44 844 835 9555
www.habasit.co.uk

USA

Habasit America
Suwanee, Georgia
Phone: +1 800 458 6431
www.habasitamerica.com

Headquarters

Habasit AG
Römerstrasse 1
CH-4153 Reinach, Switzerland
Phone +41 61 715 15 15
Fax +41 61 715 15 55
E-mail info@habasit.com
www.habasit.com



Registered trademarks
Copyright Habasit AG
Subject to alterations
Printed in Switzerland
Publication data:
2055RO.WOD-en0515HQR