

Printing and Paper Industry Belts, Tapes and Chains

Habasit – Solutions in motion

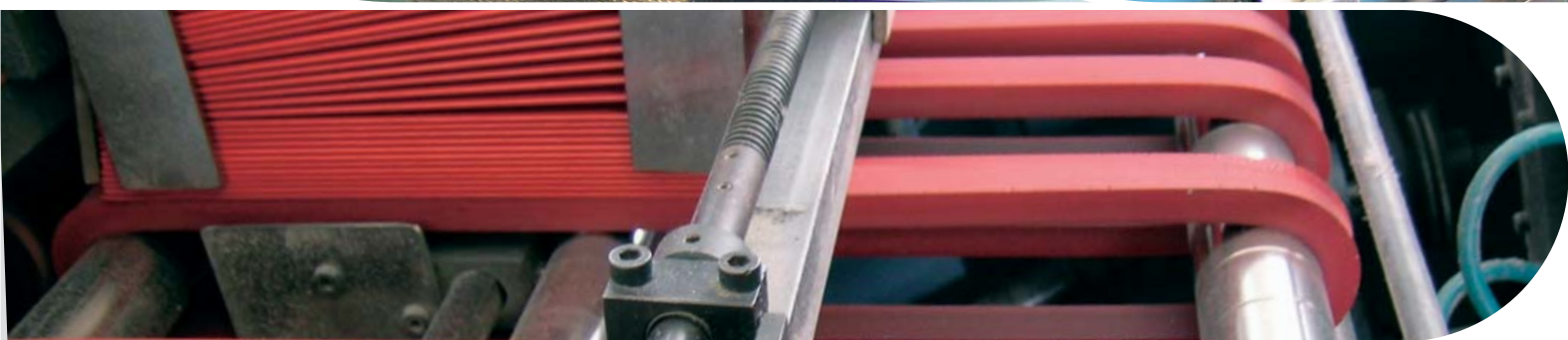
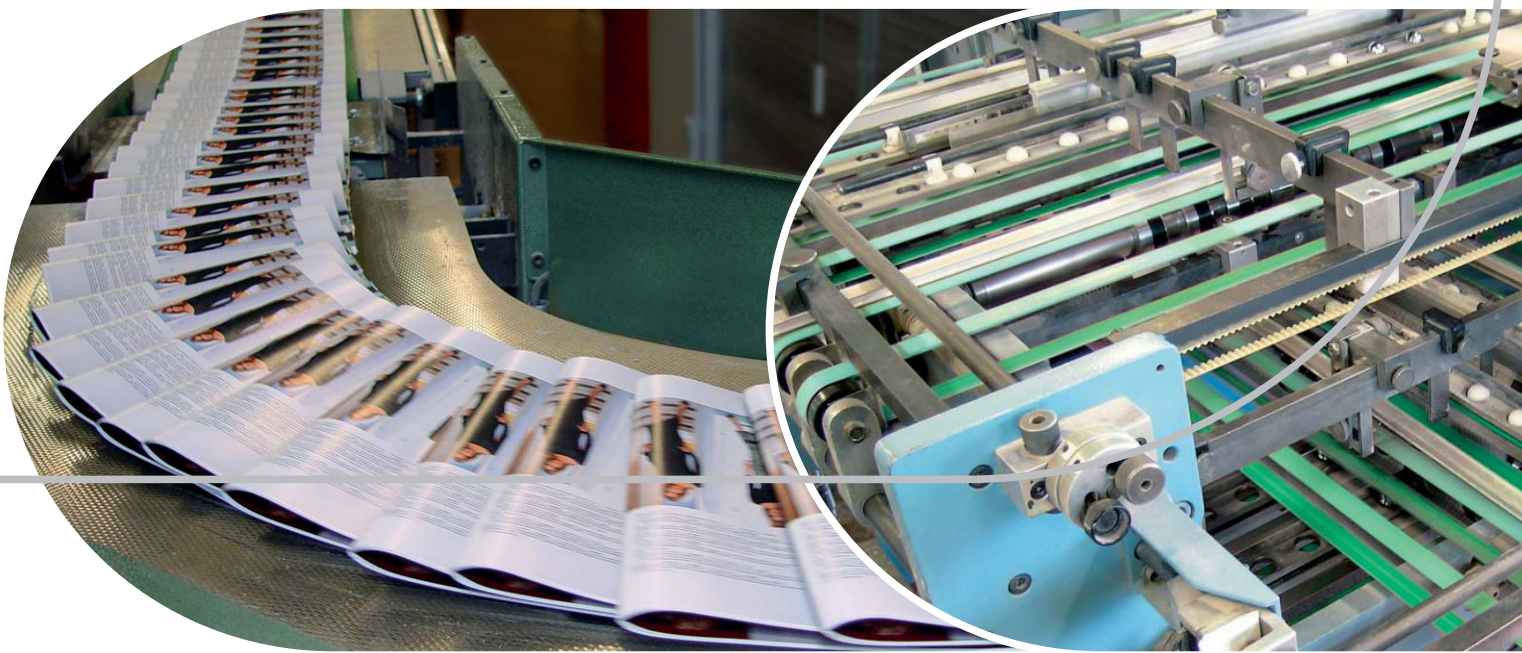

Introduction	3
Application process overview	4 – 5
<ul style="list-style-type: none"> • Cross-cutter/sheeter (incl. conveyor/palletizer) • Gatherer and binder • Sheet folding machine • Gluing and binding machine • Envelope machine • Writing pad machine 	
Application process overview	6 – 7
<ul style="list-style-type: none"> • Newspaper/magazine production (incl. folder) • Conveyor/palletizer • Corrugated cardboard manufacturing line • Die-cutter • Folder-gluer machine/boxmaking machine 	
Belts by application	8 – 11
Habasit product ranges	12
Product surface properties and structures	13
Application needs and product properties	14 – 17
Services	18
The Habasit solution	19
Habasit worldwide	20

Product liability, application considerations

If the proper selection and application of Habasit products are not recommended by an authorized Habasit sales specialist, the selection and application of Habasit products, including the related area of product safety, are the responsibility of the customer. All indications / information are recommendations and believed to be reliable, but no representations, guarantees, or warranties of any kind are made as to their accuracy or suitability for particular applications. The data provided herein are based on laboratory work with small-scale test equipment, running at standard conditions, and do not necessarily match product performance in industrial use. New knowledge and experiences can lead to modifications and changes within a short time without prior notice. BECAUSE CONDITIONS OF USE ARE OUTSIDE OF HABASIT'S AND ITS AFFILIATED COMPANIES' CONTROL, WE CANNOT ASSUME ANY LIABILITY CONCERNING THE SUITABILITY AND PROCESS ABILITY OF THE PRODUCTS MENTIONED HEREIN. THIS ALSO APPLIES TO PROCESS RESULTS / OUTPUT / MANUFACTURING GOODS AS WELL AS TO POSSIBLE DEFECTS, DAMAGES, CONSEQUENTIAL DAMAGES, AND FURTHER-REACHING CONSEQUENCES.

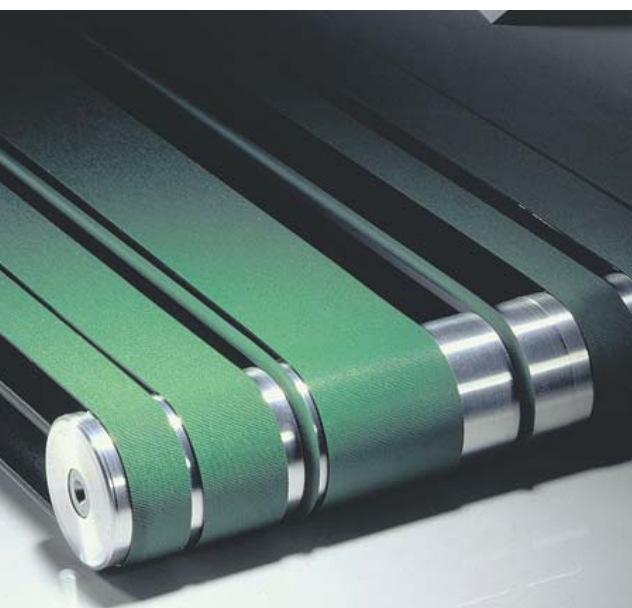

The key element: belts

Production processes in the printing and paper industry require a vast range of different belts. Profound industry know-how, and ongoing research, innovation and contact with leading machine manufacturers worldwide enable Habasit to develop solutions that respond to the latest market needs, e.g. folder belts for web-fed printing machines. All our developments focus on user-friendly solutions that combine high performance and reliability with an attractive price/value ratio.

Your one-stop shop

Our one-stop shop policy means that customers can obtain all their belting-related products and services from the same supplier, thereby reducing purchasing and logistics complexity and costs. An important feature of our technical consultancy is that since we are not restricted to a single type of product, we can offer an unbiased opinion on the best choice of product for each application.

Competence and experience

Habasit application engineers, technicians and joining specialists are at your disposal for professional consulting, superb customer service, and excellent support. Founded in 1946, Habasit has proven its profound understanding of customer needs for decades. Thanks to our comprehensive global network, Habasit can respond to any request with nothing less than outstanding belting solutions of the highest quality, tailored in every case to your specific needs.

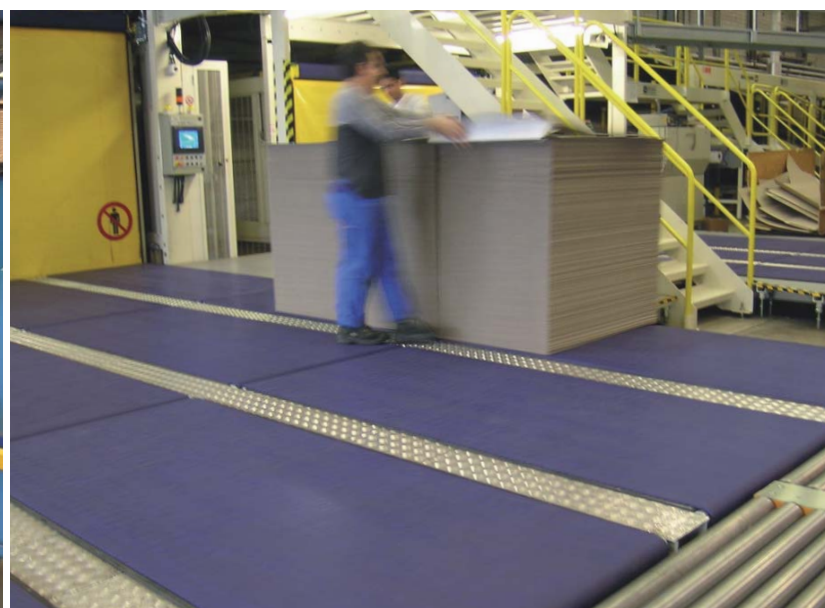
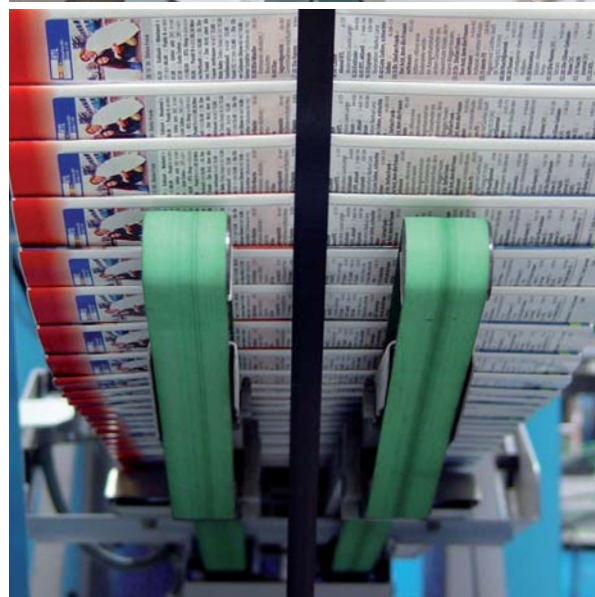

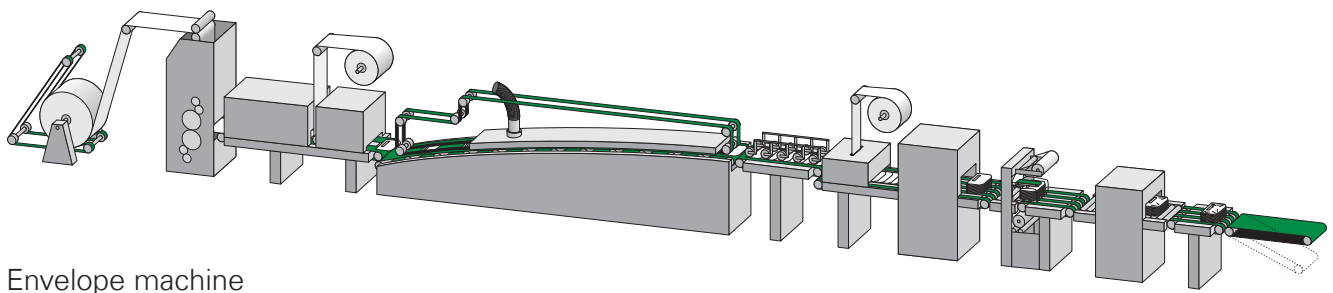
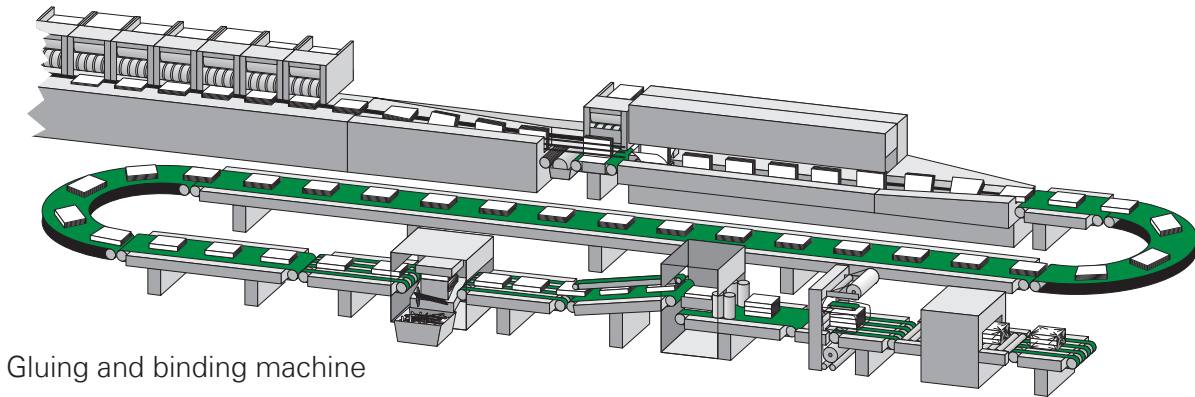
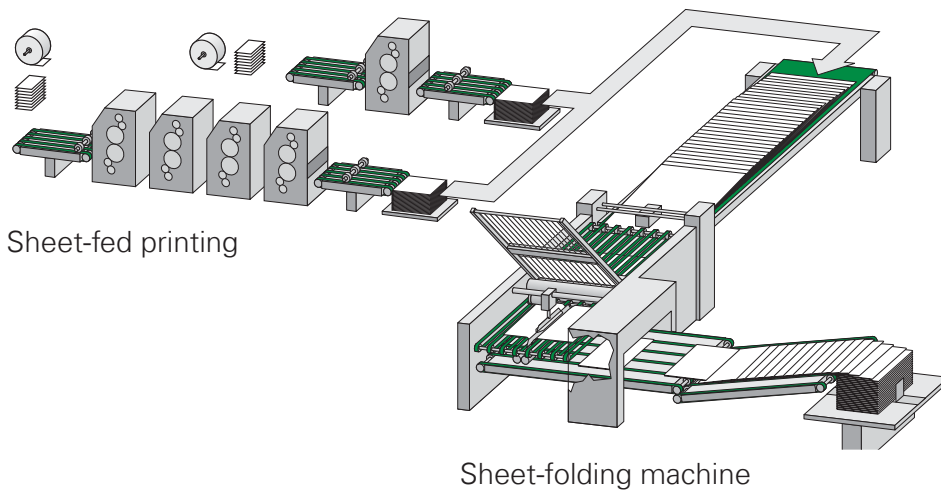
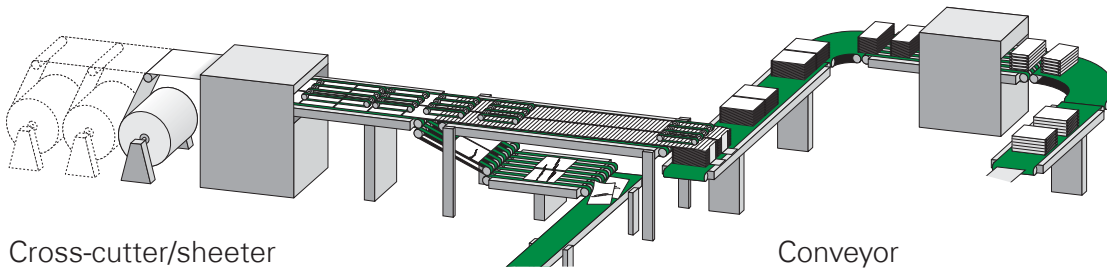

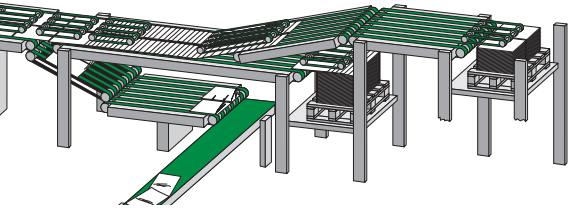

Conveyor/palletizer

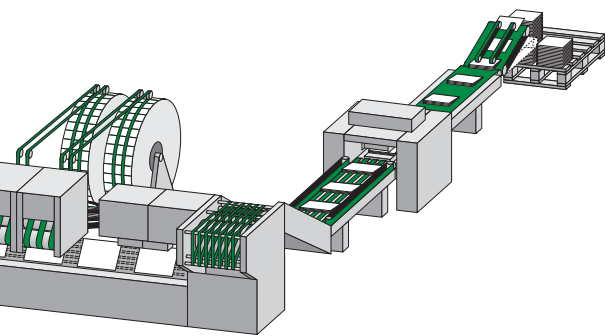

Gatherer/binder

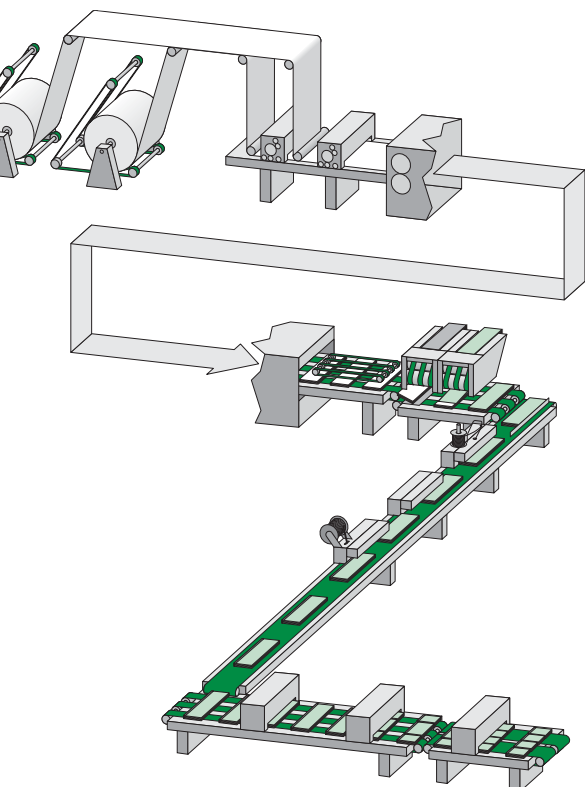

Writing pad machine

Habasit offers exactly the right belting products for every application and process step, including conveying, converting, folding, feeding, and driving.

- Machine tapes
- Folder-gluer belts
- Power transmission belts
- Seamless feeder belts
- Round belts
- Conveyor and processing belts
- Nonwoven belts
- Powerturn belts
- Modular belts
- Slat and conveyor chains
- Timing belts

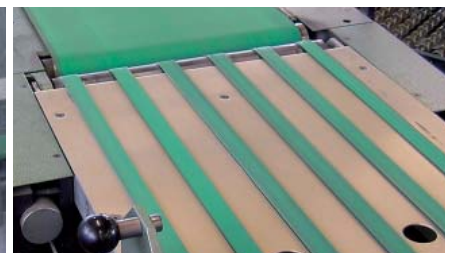
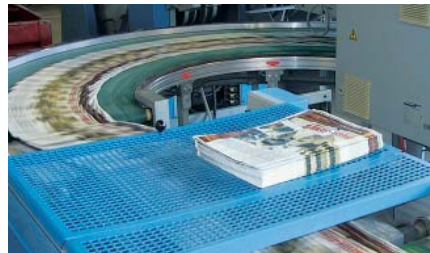

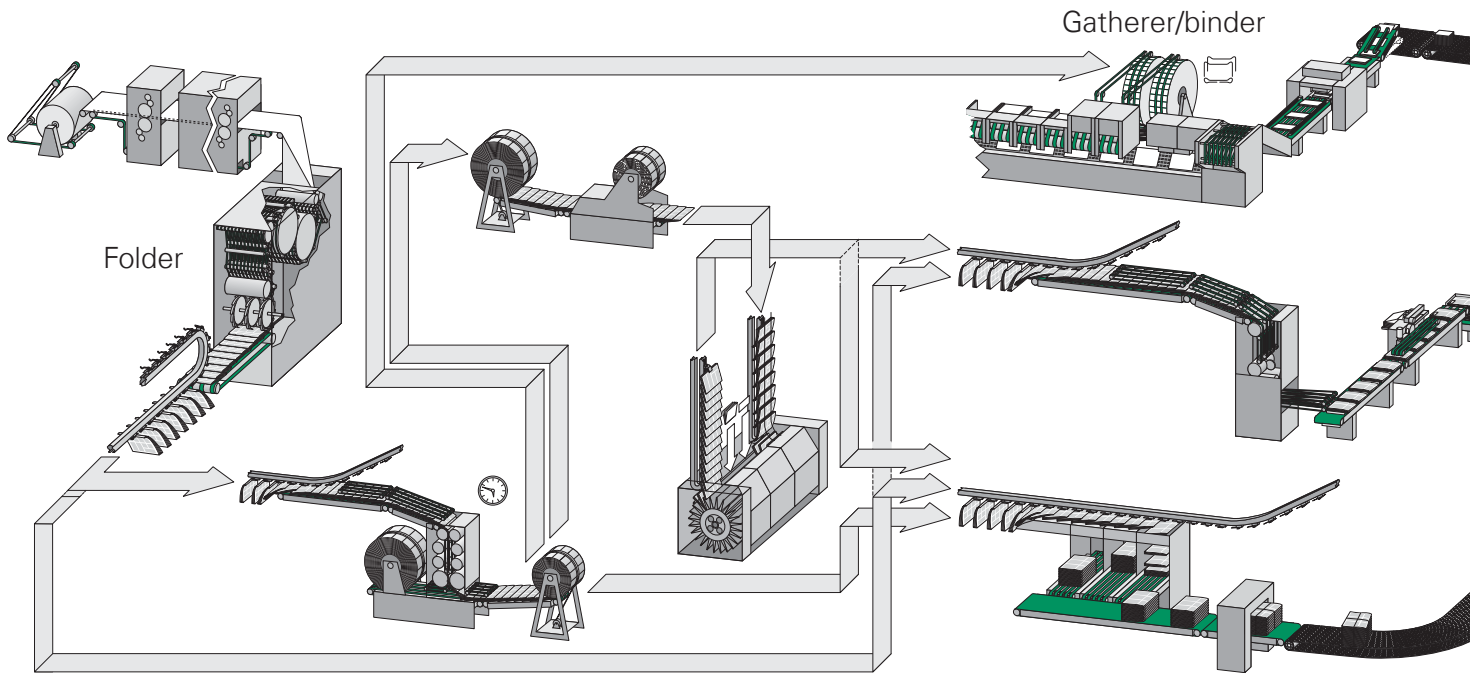

Newspaper/magazine production
Folder for web-fed (rotary) printing machine

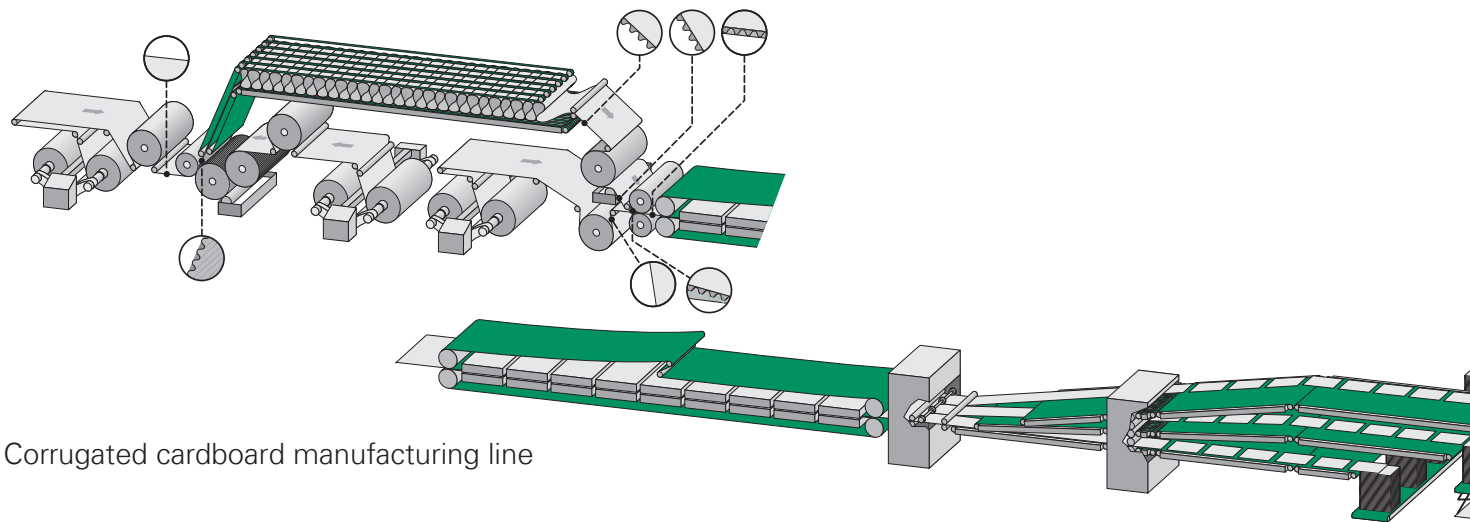

Corrugated cardboard manufacturing line

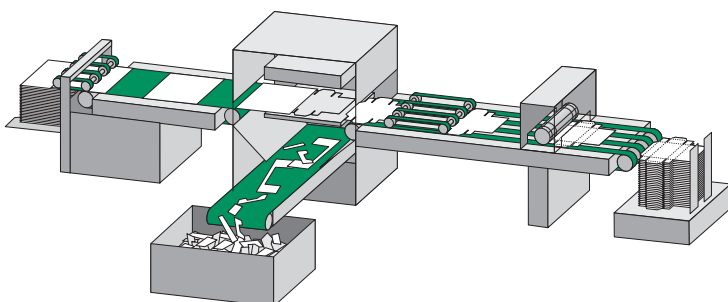

Die-cutter

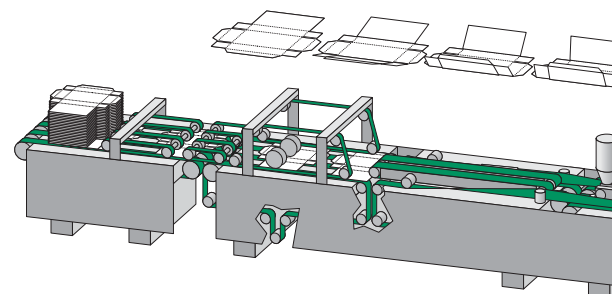

Folder-gluer machine/boxmaking machine

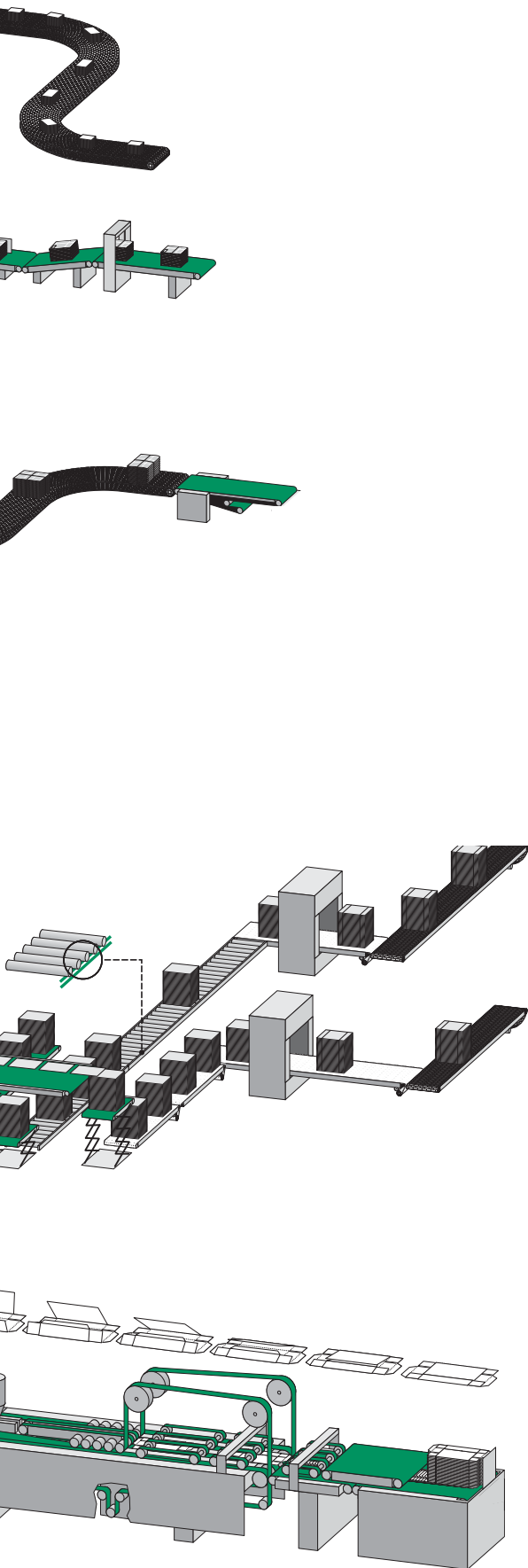

Habasit offers exactly the right belting products for every application and process step, including conveying, converting, folding, feeding, and driving.

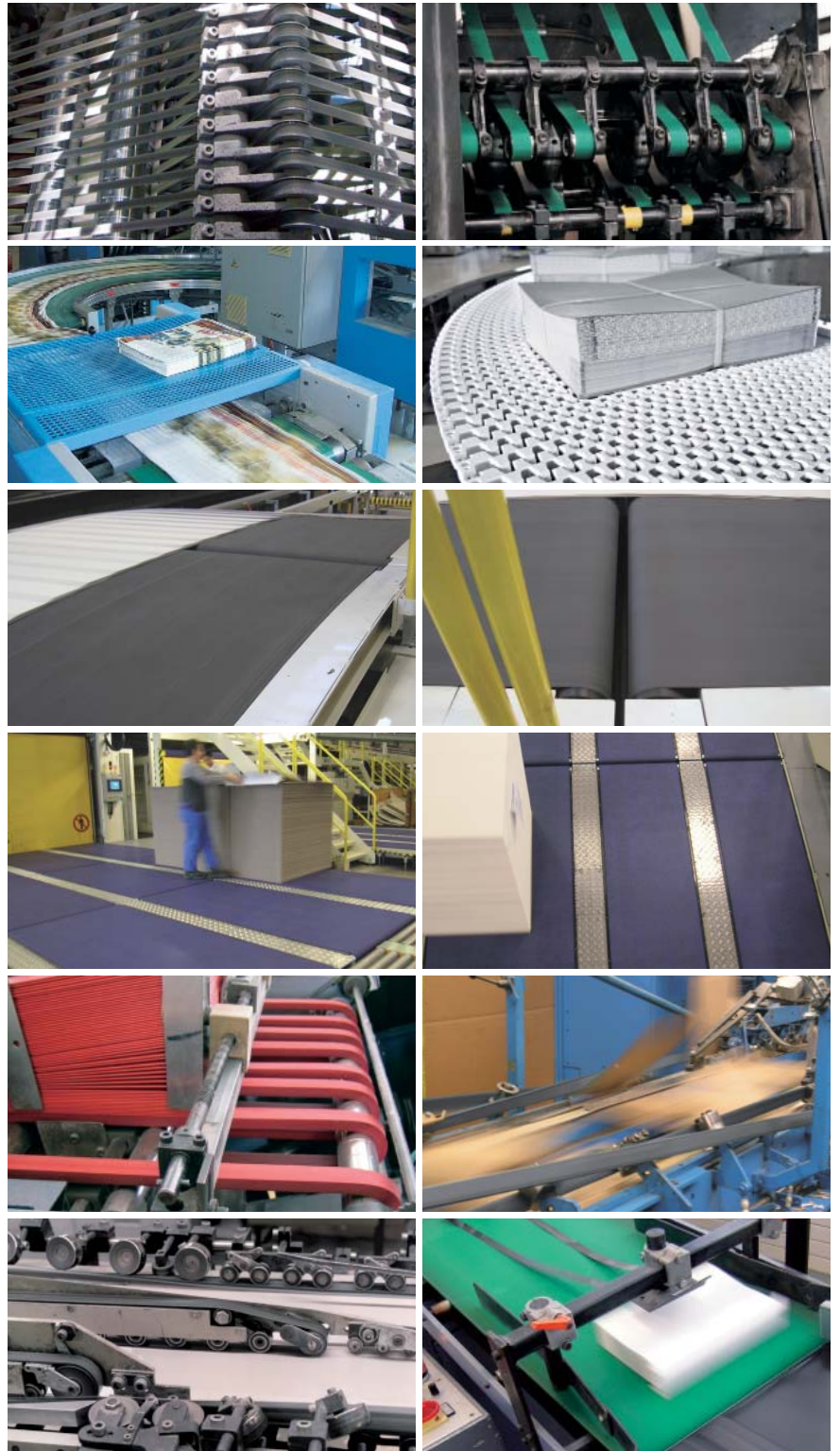

		Machine tapes																				
Product surface material		Hamid (Hamid = Habasit thermoplastic compound)																Poly- amide PA				
Belt type		MAT-02H	MAM-04H	MAB-02	MAB-05	MAM-05HIP	MAN-05H	MAB-4E	MAB-8E	MAM-5E	MAM-5P	MAM-8P	MAT-5P	MNN-10E	MNT-5P	MNI-7E	MNT-8P	MNI-10E	MVT-5E	MVT-6P	TS-55	A-1
Printing and paper application processes																						
Cross-cutter/sheeter		•	•			•	•		•	•	•	•		•	•				•	•		
Sheet feeder/layboy		•	•			•				•	•		•		•				•	•	•	
Sheet folding machine		•	•	•	•	•				•	•				•				•	•	•	
Finishing systems/bookbinding		•	•	•	•	•	•	•	•	•	•	•	•	•	•	•	•	•	•	•	•	•
Paper and cardboard converting applications		•	•	•	•	•	•	•	•	•	•	•	•	•	•	•	•	•	•	•	•	•
Newspaper and magazine production (printing-/mailroom)		•	•	•	•	•		•	•	•	•	•	•		•				•	•	•	•
Folder for web-fed printing machine												•		•	•	•	•	•		•		
Corrugated cardboard manufacturing																			•	•		
Folder-gluer/boxmaking machine																						
Tubewinder																						
Tissue and diaper production		•	•	•	•	•		•	•	•	•	•	•		•				•	•		
Paper conveying (incl. palletizer)		•	•	•	•	•	•	•	•	•	•	•	•	•	•	•	•	•	•	•	•	•
Cardboard conveying										•	•								•	•		•
General applications																						
Feeder belt/pick-off belt																						
Driving belt										•											•	•

The selection tables contain standard materials and are recommendations only. Due to the complexity of various processes, technical requirements and external influences (e.g. the shape and size of the transported goods, process speed, treatment stages/handling, environment or process temperature, humidity, chemicals, etc.) other belt types or materials may be used as well. No guarantee is made as to completeness and/or suitability for particular applications. For details or further information, please contact your local Habasit partner.

Product surface material		Conveyor and process																
		Polyvinylchloride PVC																
Belt type	NBR-, EPD																	
	NAB-5EKBV	NHB-5EKBV	NSW-5ELAV	NHM-8EKBV 11	NMM-10EBAV 09	NHB-10EKBV	SAB-5E 07	SAW-5E 07	SNB-5E 07	SAB-8E 07	SAG-8E 07	SAQ-8E 07	SNB-8E 07	SAG-12E	HAM-5P	HNI-5P	HNI-5PE	
Printing and paper application processes																		
Cross-cutter/sheeter																•	•	•
Sheet feeder/layboy																•	•	•
Sheet folding machine																•	•	•
Finishing systems/bookbinding																•	•	•
Paper and cardboard converting applications	•	•	•	•	•	•	•	•	•	•	•	•	•	•	•	•	•	•
Newspaper and magazine production (printing-/mailroom)																•	•	•
Folder for web-fed printing machine																	•	•
Corrugated cardboard manufacturing	•	•	•	•	•	•	•	•	•	•	•	•	•	•				
Folder-gluer/boxmaking machine											•			•				
Tubewinder																		
Tissue and diaper production																•	•	•
Paper conveying (incl. palletizer)	•	•	•	•	•	•	•	•	•	•	•	•	•	•	•	•	•	•
Cardbord conveying	•	•	•	•	•	•	•	•	•	•	•	•	•	•	•			
General applications																		
Feeder belt/pick-off belt																		
Driving belt																		
Conveyor belt	•	•	•	•	•	•	•	•	•	•	•	•	•	•				
Incline belt																		
Powerturn belt				•	•													

The selection tables contain standard materials and are recommendations only. Due to the complexity of various processes, technical requirements and external influences (e.g. the shape and size of the transported goods, process speed, treatment stages/handling, environment or process temperature, humidity, chemicals, etc.) other belt types or materials may be used as well. No guarantee is made as to completeness and/or suitability for particular applications. For details or further information, please contact your local Habasit partner.

	Machine tapes	Hamid machine tapes
		Polyamide PA machine tapes
	Folder-gluer belts	Polyamide PA folder-gluer belts
		Polyester PET folder-gluer belts
	Driving or power transmission belts	Aramide AR power transmission belts
		Polyamide PA power transmission belts
		Polyester PET power transmission belts
	Round belts Polycord®	Thermoplastic polyurethane TPU round belts
	Seamless belts	Rubber-coated seamless belts (Grabber®)
		Rubber-impregnated traditional style seamless belts
	Fabric-based conveyor belts	PVC coated belts
		NBR-, EPDM-, fabric -, TPU covers
		Nonwoven (fleece) PET belts
	Plastic modular belts HabasitLINK® and KVP®	Large variety of plastic materials
	Slat and conveyor chains HabaCHAIN®	Large variety of plastic materials
	Polyurethane timing belts HabaSYNC®	With steel cord tensile member
		With aramide tensile member
		Tailor-made belt covers

Complementary products

Profiles, guides, wear strips: Extruded profiles (HabiPLAST®) in PE, PA, POM, PET, PTFE, PVC, and PP are an ideal complement for slat and conveyor chains and modular belts.

Gearmotors: Rossi, a member of the Habasit Group, is one of Europe's largest manufacturers of gear reducers, gearmotors, inverters, and standard and brake motors.

The belt surface plays a key role in meeting each specific process step or function. There are many functional possibilities, depending on the surface structure and the inherent properties of the material. The following table indicates the variety of belt surface structures and properties available from Habasit.



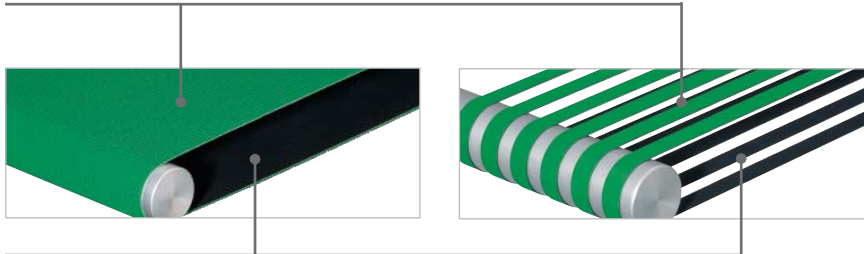





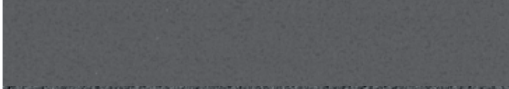

Belt or tape conveying side



Belt or tape surface properties

- Non-adhesive
- Hard non-adhesive
- Medium adhesive
- Adhesive
- Super adhesive
- Super soft adhesive

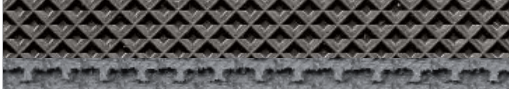
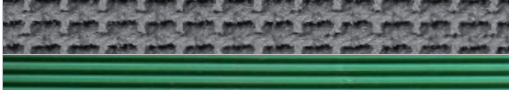
Running side or pulley side (reverse side)

Enlarged product surface structure (selection only)	Surface structure for the conveying side or the running pulley (reverse) side
	Blank, smooth
	Mat (dull finish)
	Sand finish
	Fine structure (textile impression)
	Rough structure (rough textile impression)
	Fabric (textile structure)
	Impregnated fabric (impregnated textile structure)
	Nonwoven (fleece, buffed or ground finish)
	Quadrillé (quadrangular pattern)
	Waffle structure
	Grip structure (rough top)
	Longitudinal groove structure

The content of this table gives general indication about features and benefits of a particular product group. Please see product data sheet for detailed information about specific products: www.habasit.com		Machine tapes		Folder-gluer belts
		Hamid (Habasit thermoplastic compound)	Polyamide PA	Polyamide PA
Application need				
Product features and performance	Gentle treatment of goods	•	•	•
	No marking or smearing of ink	•	•	•
	Copes with small pulley diameters	•	•	
	Uniform longitudinal flexibility thanks to the adhesive-free joint	•		• ¹⁾
	Forgiving operation at intermittent overloads	•	•	•
	Uniform driving conditions, very low creep			
	Good and precise acceleration of paper and cardboard	•	•	•
	Precise folding process	•	•	•
	Precise feeding function	•	•	•
	Low energy consumption	•		
	Reliable conveying and driving properties, constant coefficient of friction	•	•	•
	Outstanding resistance to flex-fatigue and aging	•	•	•
	Stable modulus of elasticity after running-in, no re-tensioning	•	•	•
	No need for belt tensioning devices	• ¹⁾		
	High dimensional stability	•	•	•
	Low sensitivity to humidity	•		• ¹⁾
	Suitable for compact designs	•	•	
	Elastic belts	• ¹⁾		
	Extremely thick rubber cover			• ¹⁾
	Suitable for angular gears			
Joining and installation	Adhesive-free joint (simple and fast Flexproof joining method)	•		• ¹⁾
	Adhesive-free butt joint (Quickmelt weld joining method)	• ¹⁾		
	Only minimum joining equipment needed	•		• ¹⁾
	Quick and easy installation, easy handling	•		• ¹⁾
	Short machine downtimes	•		• ¹⁾
	Adhesive-based joining method (Thermofix)		•	• ¹⁾
	Seamless, no joining needed			

¹⁾ selected types only

	Driving belts, power transmission belts			Round belts Polycord®	Seamless belts, feeder belts	
Polyester PET	Aramide AR	Polyamide PA	Polyester PET	Thermoplastic polyurethane TPU	Rubber-coated seamless belts (GRABBER® series)	Rubber-impregnated traditional seamless belts (Panther and Apache series)
•	•	•	•		•	•
•						
	•	•	•	•		•
•	•		•	•		
•		•	•	•		
	•		•			
•					•	•
•						
•	•		•	•		•
•	•	•	•	•	•	•
•	•	•	•	•	•	•
•	•	•	•	•	•	•
				•	• ¹⁾	• ¹⁾
•	•	•	•		•	•
•	•		•	•	•	•
•	•	•	•	•		•
				•		• ¹⁾
					• ¹⁾	
				•		
•	•		•			
				•		
•	•		•	•		
•	•		•	•		
•	•		•	•		
		•				
					•	•

The content of this table gives general indication about features and benefits of a particular product group. Please see product data sheet for detailed information about specific products: www.habasit.com		Conveyor and processing belts	
		Polyvinylchloride PVC coated	NBR-, EPDM-, fat TPU covers
Application need			
Product features and performance	Application-oriented belt surface properties (adhesive, non-adhesive)	●	●
	Application-oriented belt surface structures (blank, fine or rough structured, pure fabric, fabric impregnated, quadrillé, waffle structured, grip structured, longitudinal groove structured)	●	●
	Application-oriented belt strength classes and traction layers	●	●
	Gentle, soft and safe handling of conveyed goods	●	●
	No marking or smearing of ink	● ¹⁾	● ¹⁾
	Good and precise acceleration of paper and cardboard	●	●
	Copes with small pulley diameters	●	●
	Uniform longitudinal flexibility thanks to the adhesive-free joint	●	● ¹⁾
	Forgiving operation at intermittent overloads	●	●
	Damping capability due to greater belt thickness	● ¹⁾	● ¹⁾
	Reliable conveying properties, constant coefficient of friction	●	●
	Suitable for compact designs	●	●
	Nosebar design or tooth comb design	● ¹⁾	● ¹⁾
	Lightweight belt design for heavy-duty operation	●	●
	High dimensional stability	●	●
	Low sensitivity to humidity	●	●
	Flame-retardant	● ¹⁾	● ¹⁾
	Low-noise design for slider bed	● ¹⁾	● ¹⁾
	Cut-resistant belt surface		● ¹⁾
	Nonwoven (fleece) material surface		
	Impact and wear resistant		
	Suitable for rough and rugged applications	● ¹⁾	● ¹⁾
	Edge fray resistance		
	Positive drive and tracking by belt engagement with sprockets		
	Radius and straight conveying with a single belt		
	Belt can be used as people mover		
	High lateral stiffness		
	Accurate positioning, linear movement option		
	Suitable for multi-lane synchronized conveying		
	Suitable for accumulation		
Combinations with various cover materials			
Suitable for linear movement			
Joining and installation	Adhesive-free joint (simple and fast Flexproof joining method)	●	● ¹⁾
	Quick and easy installation, easy handling	●	● ¹⁾
	Quick and easy assembling		
	Short machine downtimes	●	● ¹⁾
	Easy repair of single belt or chain modules		
	Adhesive-based joining method (Thermofix)		● ¹⁾

¹⁾ selected types only

		Modular belts HabasitLINK® and KVP®	Slat and conveyor chains HabaCHAIN®	Timing belts HabaSYNC®
oric -,	Nonwoven (fleece) PET	Plastic modular belts in a large variety of materials, including PP, PE, POM, PA and special materials	Slat and conveyor chains in a large variety of materials, including PP, PE, POM and special materials	Polyurethane timing belts with steel or aramide tensile members with metric and imperial pitches
	• ¹⁾	•	•	•
		•	•	•
	•	•	•	•
	•	•	•	•
	• ¹⁾			•
	• ¹⁾	• ¹⁾		
	•			
	•	•	•	•
	•	• ¹⁾		•
		•	•	•
		• ¹⁾		
		• ¹⁾		
	•	•		
		•	•	•
	•	•	•	•
	•	•	•	•
	•	•	•	•
	•	• ¹⁾	• ¹⁾	
	•			
	•	•	•	•
		•	•	•
		•	•	•
		• ¹⁾	• ¹⁾	• ¹⁾
		•		•
		•	•	•
		•	•	•
		• ¹⁾	• ¹⁾	• ¹⁾
		•	•	•
			•	•
			•	•
		• ¹⁾	• ¹⁾	• ¹⁾
				•
				•
	•			•
	•	•	•	•
		•	•	•
	•	•	•	•
		•	•	•

Comprehensive services are central to Habasit’s belting solution approach.

As committed partners to our customers, we are dedicated to sharing our knowledge and to providing full support.



Comprehensive consulting and technical support

Habasit offers the best consulting and technical support on the belting market. Everything revolves around our customers and each affiliate has its own belting experts. The Habasit team is proud to provide the highest levels of support together with top-quality products that have been leaders on the global market for decades.

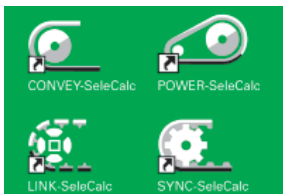

Assistance with belt selection and calculation

We will select and calculate the most suitable belt for your specific application. You also may do this yourself with our state-of-the-art Habasit selection and calculation program “SeleCalc.” To order this program free of charge, simply call your nearest Habasit partner or contact: info@habasit.com.



Fabrication, assembly and local installation services for quick reaction times

We make belts endless or assemble modular belts or chains, either at our own locations or on-site directly on your machine or system. Habasit operates over 30 affiliated companies worldwide, each with its own inventory, fabrication, assembly and service facilities. Together with our representative offices and numerous qualified distributors, we can react quickly, competently and reliably to satisfy all your demands.



Customer training programs

Habasit offers training programs and provides support tools to ensure optimal use of our products and to prolong their lifetimes. Training on fabrication, installation, assembly, maintenance and belt repair takes place at Habasit sites or at your location.



Belt monitoring, inspections, analyses and process optimization proposals

We organize and handle belt maintenance, inspections, analyses and surveys for your locations. On request we will also work with you to develop optimization proposals, for example, to achieve added value from the machinery or process output.



Design assistance for customized solutions

Habasit believes in partnership. Our engineering team will work closely with your engineers on joint design developments, preferably from a very early stage. We particularly recommend this for projects involving new technologies or large-scale modifications and adaptations.



Customers first

At Habasit we understand that our success depends on your success. This is why we offer solutions, not just products; partnership, not just sales. Since our foundation in 1946, Habasit has brought this understanding of customer needs to life every day and for every application. That's why we're the No. 1 in belting today. Worldwide. Learn more on www.habasit.com

Committed to innovation

Habasit is strongly committed to the continuous development of innovative, value-added solutions. Over 3% of our staff are dedicated exclusively to R&D, and our annual investment in this area exceeds 8% of turnover.

Certified for quality

We deliver the highest quality standards not only in our products and solutions, but also in our employees' daily work processes. Habasit AG is certified according to ISO 9001:2000.



Worldwide leading product range

Habasit offers the largest selection of belting, conveying, processing and complementary products in the industry. Our response to any request is nothing less than a specific, tailor-made solution.

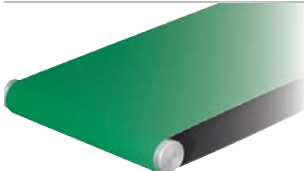

Fabric based conveyor and processing belts
HabaFLOW®

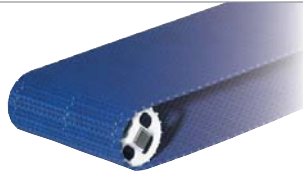

Plastic modular belts
HabasitLINK® /KVP®

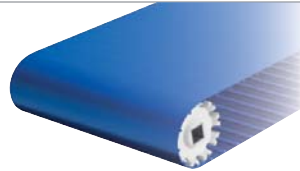

Positive drive conveyor and processing belts
Habasit Cleandrive™

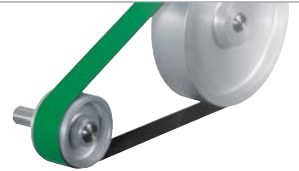

Power transmission belts
HabaDRIVE®



Timing belts
HabaSYNC®



Chains (slat and conveyor chains)
HabaCHAIN®

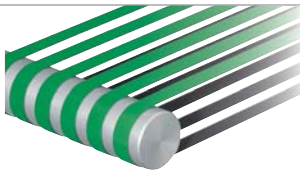

Machine tapes

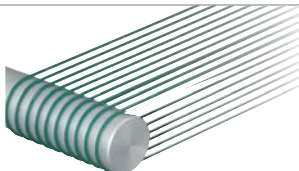

Round belts



Seamless belts

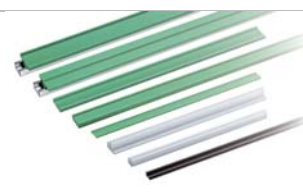

Profiles, Guides, Wear strips
HabiPLAST®



Fabrication tools (joining tools)



Gearmotors
Electric motors
Motion control

Austria

Habasit GmbH, Wien
Phone: +43 1 690 66
www.habasit.at

Belgium

Habasit Belgium N.V., Zaventem
Phone: +32 27 250 430
www.habasit.be

Canada

Habasit Canada Ltd., Oakville
Phone: +1 905 827 41 31
www.habasit.ca

China

Habasit East Asia Ltd., Hong Kong
Phone: +85 221 450 150
www.habasit.com.hk

Habasit (Shanghai) Co., Ltd.
Shanghai

Phone: +8621 5488 1228
Phone: +8621 5488 1218
www.habasit.com.hk

France

Habasit France S.A.S., Mulhouse
Phone: +33 389 338 903
www.habasit.fr

Germany

Habasit GmbH
Eppertshausen
Phone: +49 6071 969 0
www.habasit.de

India

Habasit-lakoka Pvt. Ltd., Coimbatore
Phone: +91 422 262 78 79
www.habasitlakoka.com

Italy

Habasit Italiana SpA
Customer Care:
Phone: 199 199 333
For int. calls: +39 0438 911 444
www.habasit.it

Japan

Habasit Nippon Co. Ltd., Yokohama
Phone: +81 454 760 371
www.habasit.co.jp

Netherlands

Habasit Netherlands BV, Nijkerk
Phone: +31 332 472 030
www.habasit.nl

New Zealand

Habasit Australasia Ltd., Hornby
Phone: +64 3348 5600
www.habasit.co.nz

Norway

Habasit Norge A/S, Oslo
Phone: +47 815 58 458
www.habasit.no

Poland

Habasit Polska Sp. zo.o.,
Dąbrowa Górnicza,
Phone: +48 32639 02 40
www.habasit.pl

Russia

OOO Habasit Ltd., St. Petersburg
Phone: +7 812 600 40 80
www.habasit.ru

Singapore

Habasit Far East Pte. Ltd., Singapore
Phone: +65 686 255 66
www.habasit.com.sg

Spain

Habasit Hispanica S.A.,
Barberà del Vallès
Phone: +34 937 191 912
www.habasit.es

Sweden

Habasit AB, Hindas
Phone: +46 30 122 600
www.habasit.se

Switzerland

Habasit GmbH, Reinach
Phone: +41 61 577 51 00
www.habasit.ch

Taiwan

Habasit Rossi (Taiwan) Ltd.
Taipei Hsien
Phone: +886 2 2267 0538
www.habasit.com.tw

Turkey

Habasit Kayis San. Ve Tic. Ltd. Sti.
Yenibosna - Bahcelievler - Istanbul
Phone: +90 212 654 94 04
www.habasit.com.tr

Ukraine

Habasit Ukraina, Vinnica
Phone: +38 0432 58 47 35
www.habasit.ua

United Kingdom and Ireland

Habasit Rossi (UK) Ltd., Silsden
Phone: +44 844 835 9555
www.habasitrossi.co.uk

USA

Habasit America
Conveyor belts, power
transmission belts, gearmotors
Suwanee, Georgia
Phone: +1 800 458 6431
www.habasitamerica.com

Habasit America
Seamless belts, timing belts
Middletown, Connecticut
Phone: +1 860 632 2211
www.seamlessbelts.com
www.habasync.com

Rossi is one of Europe's largest manufacturers of gear reducers, gearmotors, inverters, standard and brakemotors, and is a member of the Habasit Group.

Rossi S.p.A.
Via Emilia Ovest 915/A
41123 Modena – Italy
Phone: +39 059 33 02 88
www.rossi-group.com
info@rossi-group.com

Headquarters

Habasit AG
CH-4153 Reinach-Basel
Phone +41 61 715 15 15
Fax +41 61 715 15 55
E-mail info@habasit.com
www.habasit.com

Copyright Habasit AG
Subject to alterations
Printed in Switzerland
Publication data:
2020BRO.PAPen0112HQ