

Beverage Industry Belts, Chains and Complementary Products

Habasit-Solutions in motion



Contents, Product liability, application considerations	2
Introduction	3
Process / Application Overview (Schematic)	
• Bottle Filling	4 – 5
• Liquid Carton Production and Filling	6 – 7
• Can Filling	8 – 9
• Case, Crate and Tray Packaging and Handling	10
Variety of Product Ranges for the Beverage Industry (Overview)	11
Fold up poster: Belt Selection Table for Beverage Applications	12 – 13
• Can filling (soft drinks / beer)	
• Glass bottles (soft drinks / beer / mineral water)	
• PET (soft drinks / mineral water)	
• Liquid carton filling	
• Keg filling	
Features and Benefits: HabasitLINK® / KVP® Plastic Modular Belts	14
Bottling Specific HabasitLINK® / KVP® Plastic Modular Belts	15 – 21
Features and Benefits: HabaCHAIN® Slat and Conveyor Chains	22
Bottling Specific HabaCHAIN® Slat and Conveyor Chains	23 – 25
Features and Benefits: HabaFLOW® Fabric Coated Belts	26
Additional Information: www.habasit.com	27
Complementary Products: HabiPLAST® Profiles, Guides, Wear Strips	28
Complementary Products: Motors, Gears, Gearmotors	29
Services	30
The Habasit Solution	31
Contacts	32

Product liability, application considerations

If the proper selection and application of Habasit products are NOT recommended by an authorized Habasit sales specialist, the selection and application of Habasit products, including the related area of product safety, are the responsibility of the customer.

All indications / information are recommendations and believed to be reliable, but no representations, guarantees, or warranties of any kind are made as to their accuracy or suitability for particular applications. The data provided herein are based on laboratory work with small-scale test equipment, running at standard conditions, and do not necessarily match product performance in industrial use. New knowledge and experiences can lead to modifications and changes within a short time without prior notice.

BECAUSE CONDITIONS OF USE ARE OUTSIDE OF HABASIT'S AND ITS AFFILIATED COMPANIES CONTROL, WE CANNOT ASSUME ANY LIABILITY CONCERNING THE SUITABILITY AND PROCESS ABILITY OF THE PRODUCTS MENTIONED HEREIN. THIS ALSO APPLIES TO PROCESS RESULTS / OUTPUT / MANUFACTURING GOODS AS WELL AS TO POSSIBLE DEFECTS, DAMAGES, CONSEQUENTIAL DAMAGES, AND FURTHER-REACHING CONSEQUENCES.



Key element belts

The beverage industry includes several segments, the filling of beverages and liquids in PET, glass and cans as well as the packaging and case handling. All these processes have one thing in common: Conveyor belts build an essential part of the production line right from the start until the end, when the finished goods leave the factory. Various types and sizes of conveyor and processing belts link the different stages of production and ensure the operational reliability and efficiency of the whole plant.

Habasit offers belting solutions for:

- Bottling (returnable and one way glass bottles)
- Liquids production and filling
- Cans filling and handling
- Case, tray and crate handling

The variety of products

Habasit offers the appropriate products for all kinds of applications, including separation or accumulation, capping machines, mass handling, case packing and handling, inclined and declined conveyors, palletizing and straight and radius applications.

Product ranges for the beverage industry:

- HabasitLINK® / KVP®** (plastic modular belts)
- HabaCHAIN®** (slat and conveyor system chains)
- HabaFLOW®** (fabric based conveyor and processing belts)
- HabaDRIVE®** (power transmission belts)
- HabaSYNC®** (timing belts)
- HabiPLAST®** (profiles, guides, wear strips)
- GRABBER®** (rubber coated seamless belts)
- Rossi Gearmotors** (garmotors, gear reducers)

Your solutions partner

Habasit is totally committed to understanding your design parameters and application needs. After reviewing your requirements, our specialists will suggest the best solution for each application.

Global expertise

Over 60 years of experience, the widest and most innovative product range, and an extensive global network – Habasit is the clear No. 1 in belting worldwide. We use all our strengths to meet your needs for high-quality belting tailored to your specific requirements.



Process / Application Overview (Schematic)

Bottle Filling

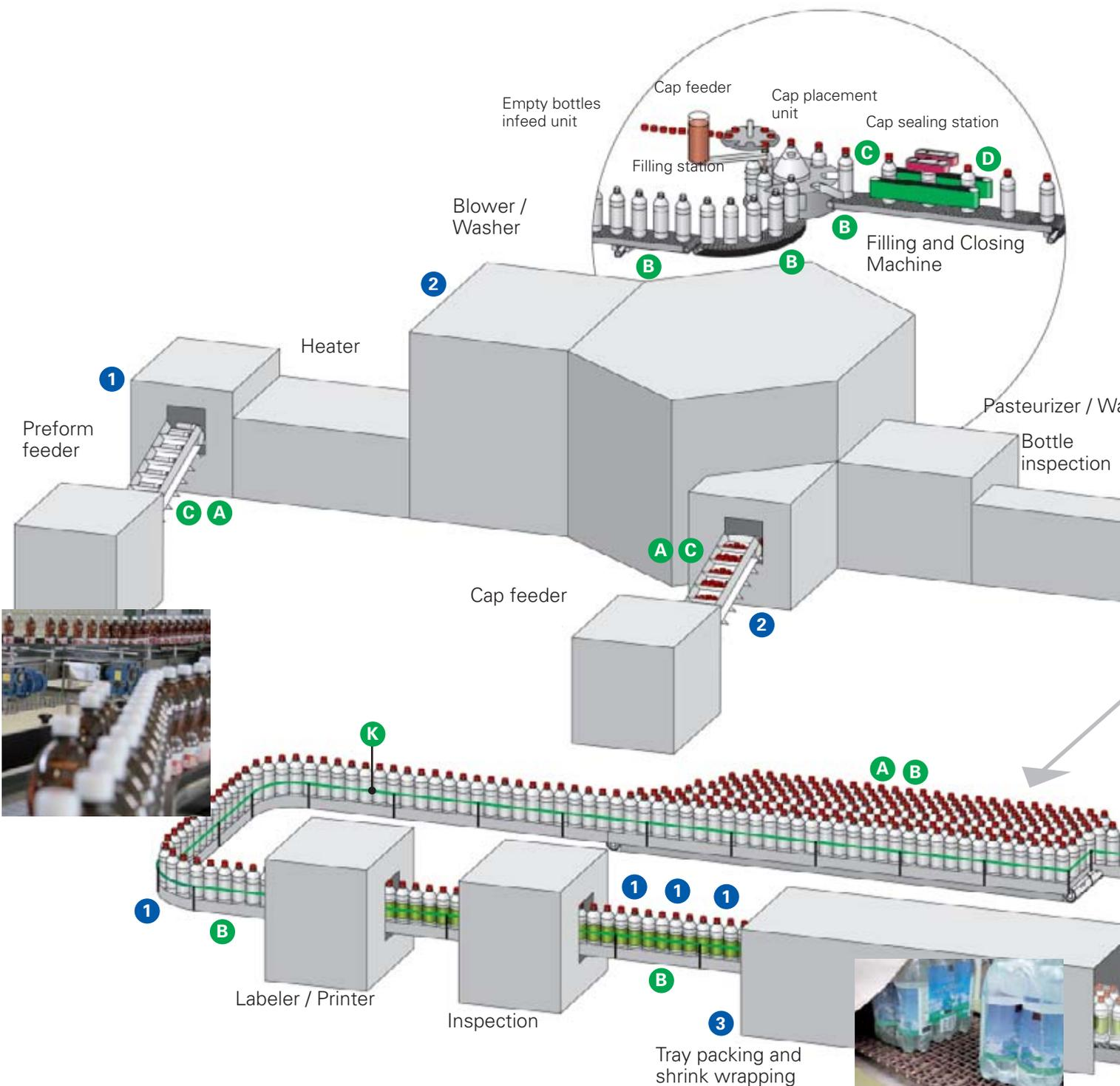



ActivXchange



armer

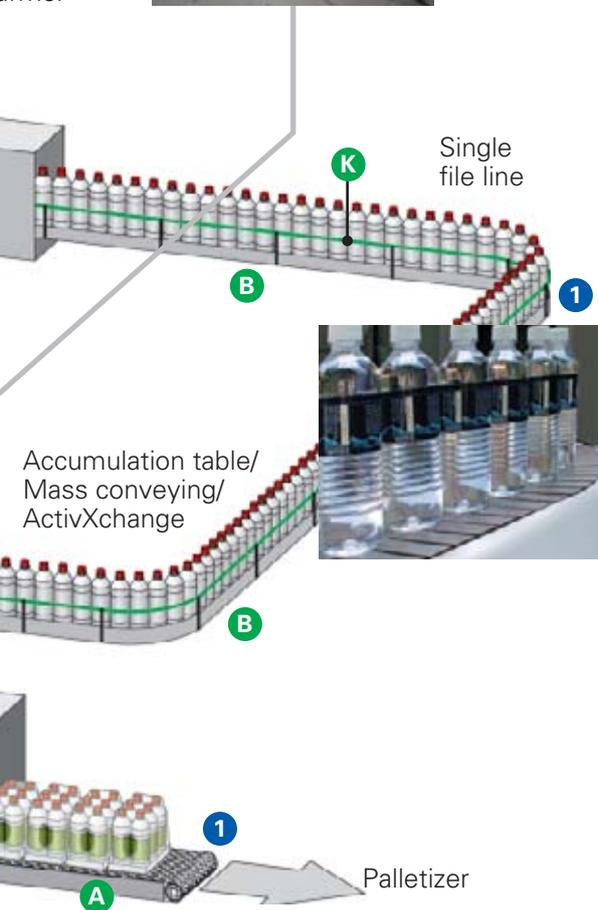

Belting products:

- A** Plastic modular belts – **HabasisLINK® / KVP®**
- B** Slat and conveyor chains – **HabaCHAIN®**
- C** Fabric based conveyor and processing belts – **HabaFLOW®**
- D** Seamless feeder belts – **GRABBER®**

Complementary products:

- K** Profiles, guides, wear strips – **HabiPLAST®**

Rossi Gearmotors

● = Possible gearmotor positions

- 1** Right angle shaft gearmotors
- 2** Worm gearmotors
- 3** Coaxial gearmotors
- 4** Planetary servogearmotors



Remark: The drawings are schematic examples of selected applications / processes. The drawings do not claim completeness. The belt recommendations (use / application / layout) are only general suggestions. Due to the complexity of various processes, technical requirements and decisive external influences (e.g. nature or property of transported goods, process speed, steps of treatment / handling, environment or process temperature, humidity, chemicals, additives, ingredients, recipes, etc.) there are many possible solutions.

Process / Application Overview (Schematic)

Liquid Carton Production and Filling

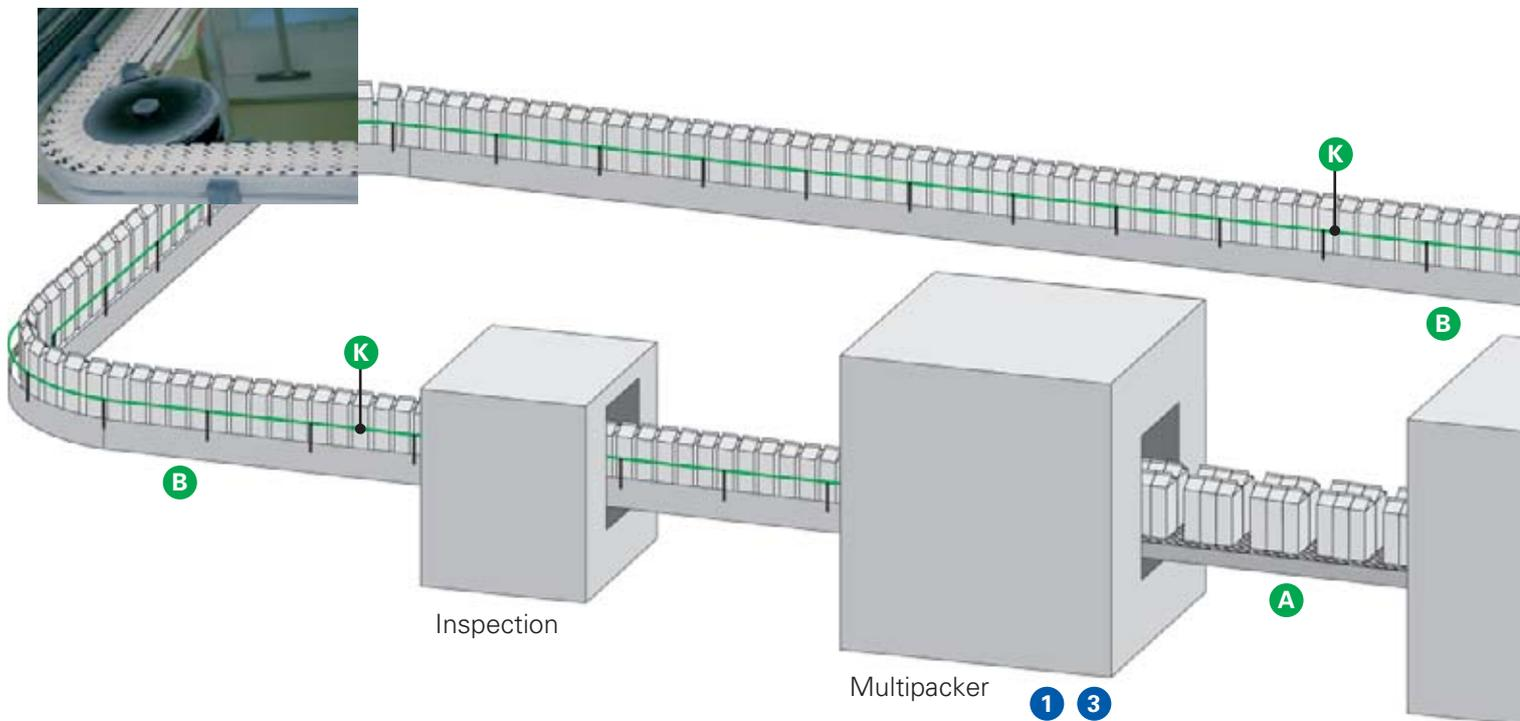
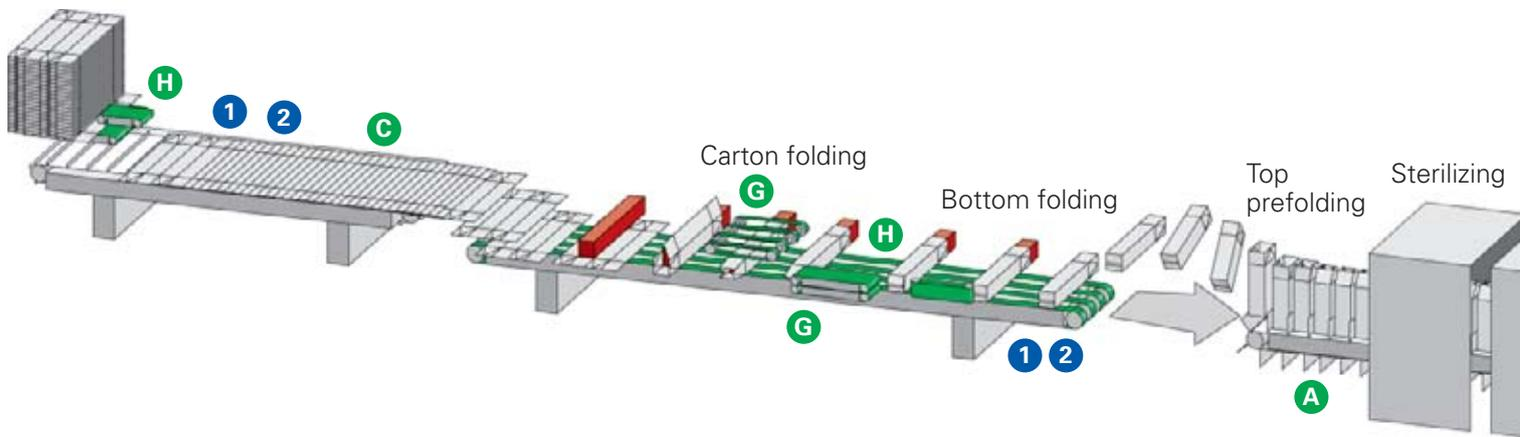



Belting products:

- A** Plastic modular belts – **HabasiLINK® / KVP®**
- B** Slat and conveyor chains – **HabaCHAIN®**
- C** Fabric based conveyor and processing belts – **HabaFLOW®**
- G** Folder-gluer-belts
- H** Machine tapes

Complementary products:

- K** Profiles, guides, wear strips – **HabiPLAST®**

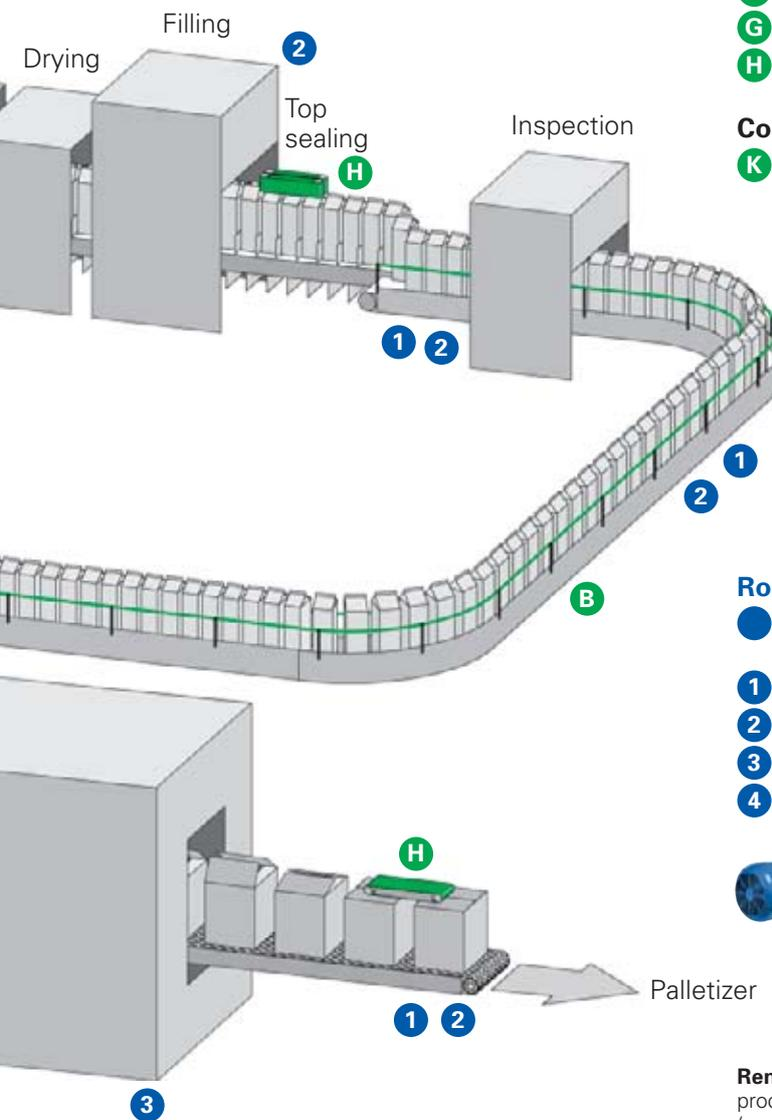

Rossi Gearmotors

● = Possible gearmotor positions

- 1** Right angle shaft gearmotors
- 2** Worm gearmotors
- 3** Coaxial gearmotors
- 4** Planetary servogearmotors



Remark: The drawings are schematic examples of selected applications / processes. The drawings do not claim completeness. The belt recommendations (use / application / layout) are only general suggestions. Due to the complexity of various processes, technical requirements and decisive external influences (e.g. nature or property of transported goods, process speed, steps of treatment / handling, environment or process temperature, humidity, chemicals, additives, ingredients, recipes, etc.) there are many possible solutions.

Process / Application Overview (Schematic)

Can Filling

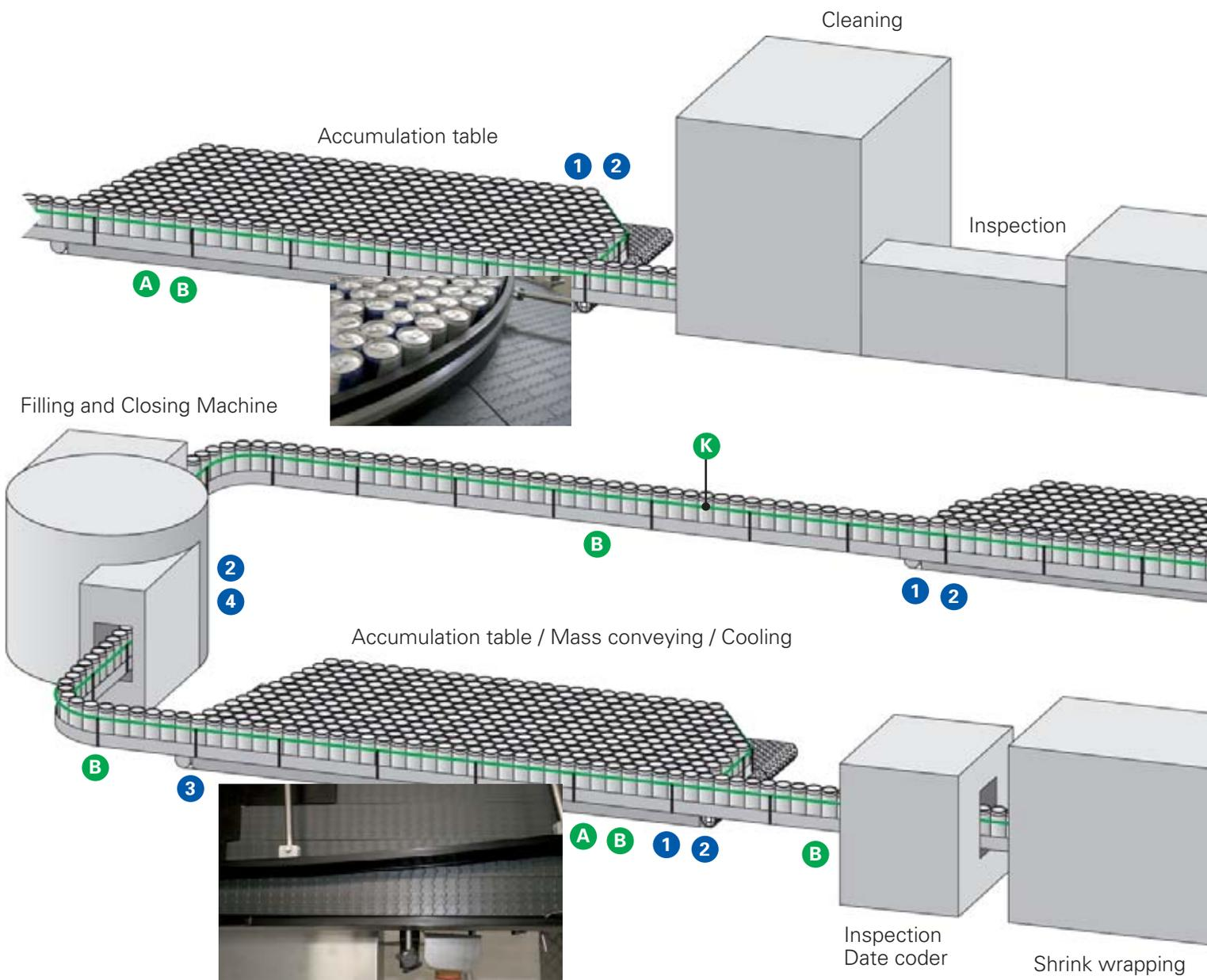



Belting products:

- A** Plastic modular belts – **HabasiLINK® / KVP®**
- B** Slat and conveyor chains – **HabaCHAIN®**

Complementary products:

- K** Profiles, guides, wear strips – **HabiPLAST®**

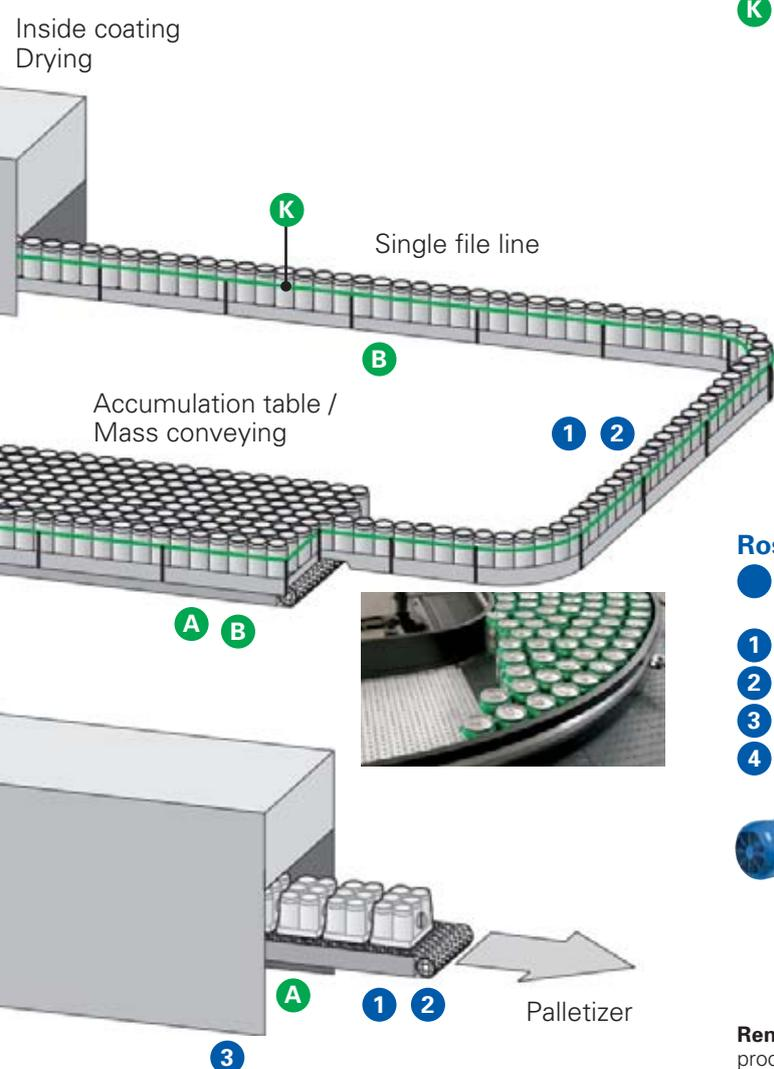

Rossi Gearmotors

● = Possible gearmotor positions

- 1** Right angle shaft gearmotors
- 2** Worm gearmotors
- 3** Coaxial gearmotors
- 4** Planetary servogearmotors



Remark: The drawings are schematic examples of selected applications / processes. The drawings do not claim completeness. The belt recommendations (use / application / layout) are only general suggestions. Due to the complexity of various processes, technical requirements and decisive external influences (e.g. nature or property of transported goods, process speed, steps of treatment / handling, environment or process temperature, humidity, chemicals, additives, ingredients, recipes, etc.) there are many possible solutions.

Process / Application Overview (Schematic)

Case, Crate and Tray Packaging and Handling

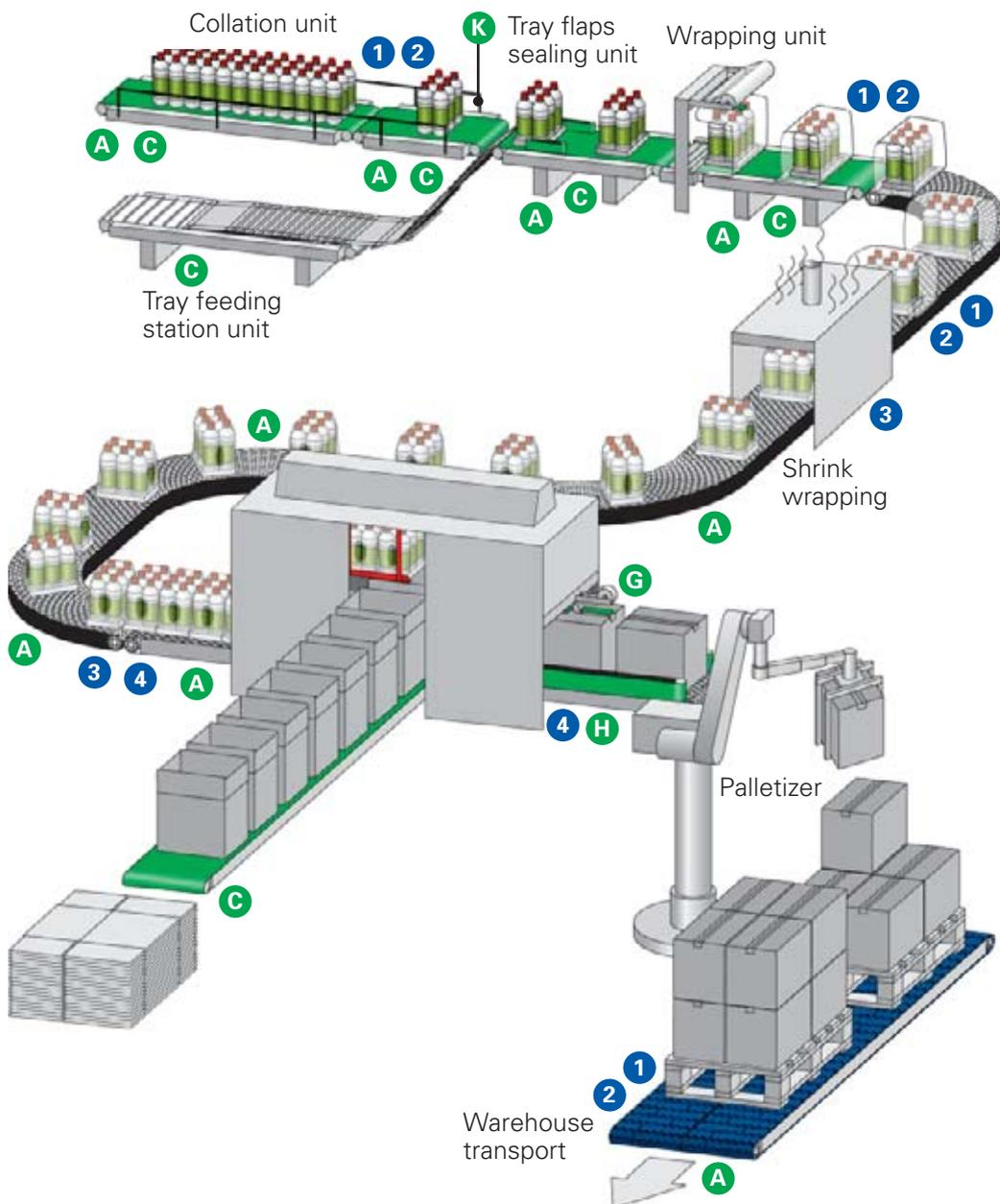

Belting products:

- A** Plastic modular belts – **Habasit-LINK® / KVP®**
- C** Fabric based conveyor and processing belts – **HabaFLOW®**
- G** Folder-gluer-belts
- H** Machine tapes

Complementary products:

- K** Profiles, guides, wear strips – **HabiPLAST®**

Rossi Gearmotors

● = Possible gearmotor positions

- 1** Right angle shaft gearmotors
- 2** Worm gearmotors
- 3** Coaxial gearmotors
- 4** Planetary servogearmotors



Remark: The drawings are schematic examples of selected applications / processes. The drawings do not claim completeness. The belt recommendations (use / application / layout) are only general suggestions. Due to the complexity of various processes, technical requirements and decisive external influences (e.g. nature or property of transported goods, process speed, steps of treatment / handling, environment or process temperature, humidity, chemicals, additives, ingredients, recipes, etc.) there are many possible solutions.

Variety of Product Ranges for the Beverage Industry

The right choice

Habasit has developed an extensive variety of solutions that allow customers to choose the best product for their specific application. Habasit is the only belt supplier to manufacture and offer the full package of belting, conveying, processing and complementary products in the industry.

Product range		Material variations / remarks	Product brochures media number	
HabasitLINK® / KVP® Plastic modular belts		<ul style="list-style-type: none"> • PA (Polyamide) • POM/AC (Polyoxymethylene/Acetal) • PP (Polypropylene) • High temperature materials 	4000	6002
HabaCHAIN® Slat and conveyor chains		<ul style="list-style-type: none"> • POM standard, low-friction, extra-low-friction, self-lubricating • Wear-resistant/wet/dry (PT) • PA heat-stabilized (NY) 	4122	6017
HabaFLOW® Fabric based conveyor and processing belts		<ul style="list-style-type: none"> • PVC coated • TPU coated • Rubber coated • Silicone coated • Nonwoven 	4063 / 4101	6000
HabaDRIVE® Power transmission belts		<ul style="list-style-type: none"> • Polyester with NBR cover • Polyamide with Habidur Rubber cover • Rubber coated seamless belts (GRABBER®) 	4132	6026
HabaSYNC® Timing belts		<ul style="list-style-type: none"> • Polyurethane • Steel cord tensile member • Aramide tensile member 	4107	6018

Complementary products

HabiPLAST® Profiles, guides, wear strips		See a more detailed description on page 28
Rossi Gearmotors Gear reducers, gearmotors, motion control, electric motors		See a more detailed description on page 29

**On this place the poster is inserted originally.
Because of PDF technical and poster size
reasons the poster is at the end of this PDF.**

Features and Benefits

HabasitLINK® / KVP® Plastic Modular Belts

Based on our comprehensive experience and our leadership position in fabric belting, Habasit has developed the HabasitLINK® / KVP® modular belt ranges. Completely ejector mark free surfaces, rounded edges, smooth designs stand for state-of-the-art hygienic modular belting. Where lubrication and downtime needs to be reduced to a minimum, modular belts are the preferred solution.

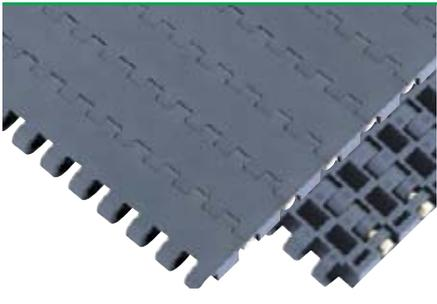
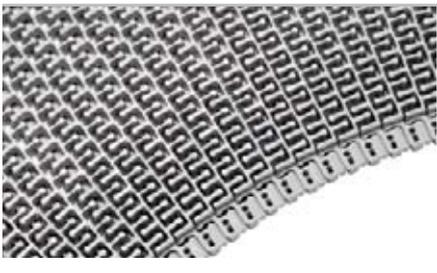
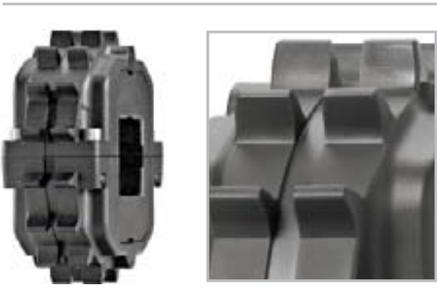
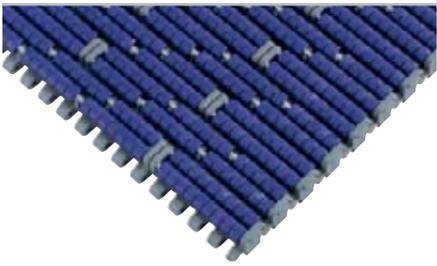

	Features	Benefits
	<ul style="list-style-type: none"> • Excellent flat surface structure • Rounded edges • Strong link design • High strength • Small opening on reverse side 	<ul style="list-style-type: none"> → Smooth running at high speed → Virtually no container tipping → Virtually no belt damage, even with broken glass (M2620 / M2670) → Downtime reduction → No space for broken glass to disengage sprocket
	<ul style="list-style-type: none"> • Radius and straight transport with one single belt 	<ul style="list-style-type: none"> → Longer runs without transfers, smaller number of drives and motors → Reduced cost for entire system
	<ul style="list-style-type: none"> • Active transfer 	<ul style="list-style-type: none"> → Smoother 90° transfers "ActivXchange" → No container tipping → Self clearing even for smallest container sizes → No catwalk → No mixed batches
	<ul style="list-style-type: none"> • Double teeth sprocket design • Split sprocket 	<ul style="list-style-type: none"> → Double lug teeth sprocket suitable for heavy loads (M2620 / M2670) → Abrasion resistant PA material → Reverse side with small openings, no space for broken glass to disengage sprocket → For easy installation
	<ul style="list-style-type: none"> • Accumulation of products with reduced back pressure • Noise and vibration absorbent materials 	<ul style="list-style-type: none"> → Less damage on bottom of package → No damage of shrunk plastic or cardboard → Smooth running, low noise

Bottling specific HabasitLINK® Plastic Modular Belts Series M1200

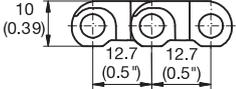
	M1220 Flat Top 0.5" + ActivXchange					
	Open area	0 %				
	Open hinge	yes				
	Belt material		PP	PE	POM	
	Rod material		PP	PE	PP	PA
Nominal tensile strength	N/m	11000	6000	16000	18000	
F _N straight run	lb/ft	754	411	1096	1233	

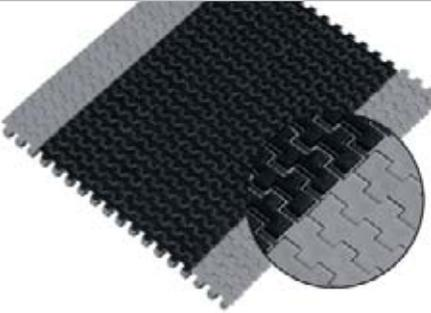
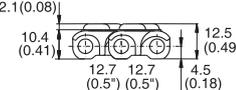
	M1220 GripTop 0.5"					
	Open area	0 %				
	Open hinge	yes				
	Belt material		PP			
	GripTop material		TPE			
Rod material		PP	POM			
Nominal tensile strength	N/m	9000	9000			
F _N straight run	lb/ft	617	617			

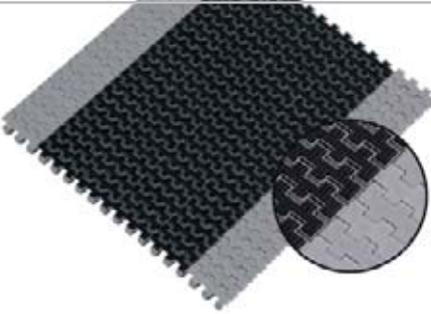
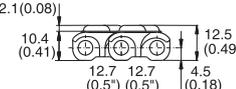
	M1220 HighGrip-L 0.5"					
	Open area	0 %				
	Open hinge	yes				
	Belt material		PP			
	GripTop material		TPE			
Rod material		PP	POM			
Nominal tensile strength	N/m	9000	9000			
F _N straight run	lb/ft	617	617			

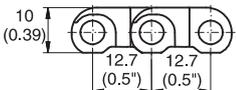
	M1230 Flush Grid 0.5"					
	Open area	18 %				
	Open hinge	yes				
	Belt material		PP	PE	POM	
	Rod material		PP	PE	PP	PA
Nominal tensile strength	N/m	11000	7000	16000	18000	
F _N straight run	lb/ft	753	480	1096	1233	



Sprocket one-piece („open window“) (S)

Split sprocket (Z)

Type	Number of teeth	Diameter of pitch Ø d _p	
		mm	inch
S	10	41.2	1.6
S	15	62.4	2.5
S	19	78.8	3.1
S	24	99.2	3.9
S	28	116.5	4.6
S	36	149.8	5.9
Z	24	99.2	3.9

Remark: Split sprocket as **multihub** sprocket in preparation.

HabasitLINK® Plastic Modular Belts

Series M2400

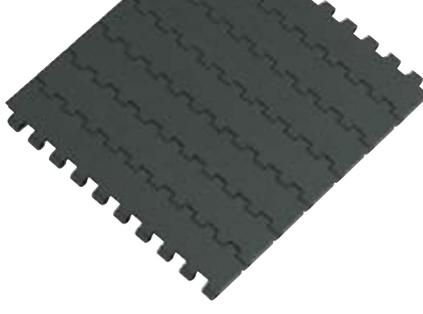

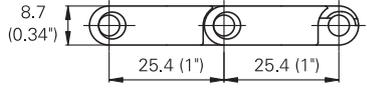
M2420 Flat Top 1"						
Open area	0 %					
Open hinge	no					
Belt material		PP		POM		
Rod material		PP	POM	PBT	PA	
Nominal tensile strength	N/m	13200	16900	20100	28800	
F _N straight run	lb/ft	904	1158	1370	1973	

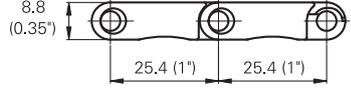

M2470 Flat Top 1" + ActivXchange						
Open area	0 %					
Open hinge	no					
Belt material		POM				
Rod material		PA				
Nominal tensile strength	N/m	30000				
F _N straight run	lb/ft	2055				



Type	Number of teeth	Diameter of pitch Ø d _p	
		mm	inch
S	12	99.5	3.9
S	18	148.3	5.8
S	12	99.5	3.9
S	15	123.9	4.9
S	18	148.3	5.8
S	20	164.6	6.4

Remark: Split sprocket as **multihub** sprocket in preparation.

Sprocket one-piece (solid) (S)

HabasitLINK® Plastic Modular Belts

Series M2500

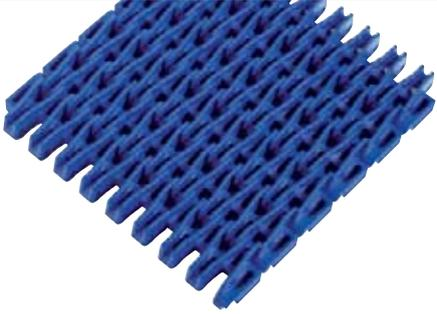
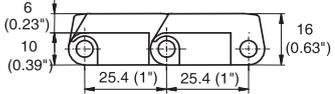
	M2531 Raised Rib 1"						
	Open area	35 %					
	Open hinge	yes					
	Belt material		PP	POM			
	Rod material		PP		PA		
Nominal tensile strength	N/m	16000	19000	27000			
F _N straight run	lb/ft	1096	1300	1850			

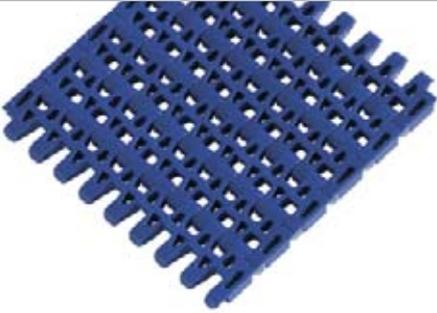
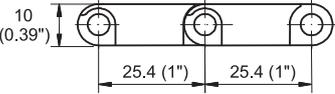
	M2533 Flush Grid 1"						
	Open area	35 %					
	Open hinge	yes					
	Belt material		PP	PE	POM	PA +US	PA
	Rod material		PP	PE	PP	PA	
Nominal tensile strength	N/m	14000	8000	18000	24700	20000	20000
F _N straight run	lb/ft	959	548	1233	1692	1370	1370

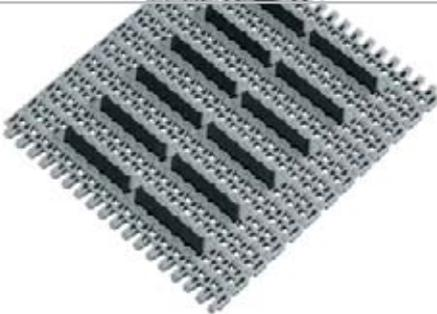
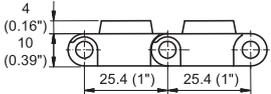
	M2533 GripTop 1"						
	Open area depends on pattern						
	Open hinge	yes					
	Belt material		PP			POM	
	GripTop material		TPE				
Rod material		PP	POM	PP	POM	PP	PA
Nominal tensile strength	N/m	14000	14000	14000	14000	18000	22000
F _N straight run	lb/ft	959	959	959	959	1233	1507

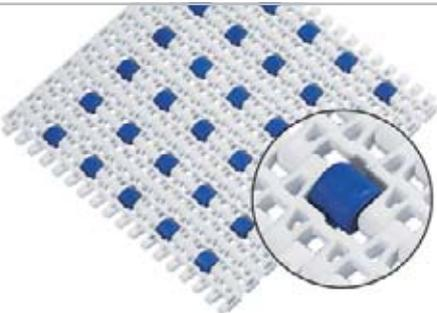
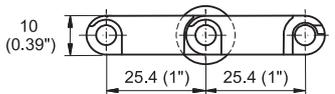
	M2533 Roller Top 1"						
	Open area	35 %					
	Open hinge	yes					
	Belt material		POM				
	Rod material		PA				
	Roller material		POM				
	Roller lateral spacing per row	mm inch	66 2.6	50 2	50 2		
	Roller offset next row	mm inch	33 1.3	0 0	0 0		
	Roller dimension diameter / width	mm inch	Ø 15 / 5 Ø 0.59 / 0.2		Ø 18 / 16 Ø 0.71 / 0.63		
	Nominal tensile strength	N/m	18500	20500	16400		
F _N straight run	lb/ft	1267	1404	1123			

HabasitLINK® Plastic Modular Belts

Series M2500

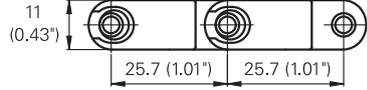
	M2585-S0 Flush Grid 1"						
	Open area	54 %					
	Open hinge	yes					
	Belt material		PA +GF	PA +HT	ST		
	Rod material		ST / Steel				
Nominal tensile strength F'_N straight run	N/m lb/ft	20000 1370	22000 1507	10000 685			

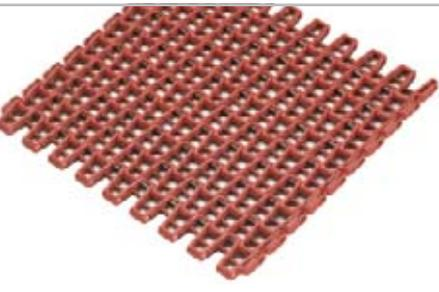
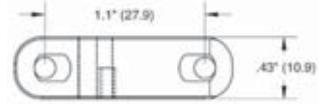
	F52 Straight 1.1" (1/2" x 1/2" Flat Wire)						
	Open area	65 %					
	Open hinge	yes					
	Belt material		PP	PE	POM	PA+GF	PA+HN
	Rod material		PP			Stainless Steel	
Nominal tensile strength F'_N straight run	N/m lb/ft	300 4378	240 3502	600 8756	600 8756	600 8756	

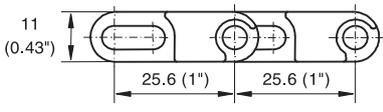
	M2540 Radius Flush Grid 1"						
	Open area	35 %					
	Open hinge	yes					
	Belt material		PP		POM	PA +US	PA
	Rod material		POM	PA			
Nominal tensile strength F'_N straight run	N/m lb/ft	19000 1300	19000 1300	27000 1850	25000 1713	25000 1713	
Nominal tensile strength F'_N in curve	N lb	1000 225	1000 225	1500 338	1300 293	1300 293	

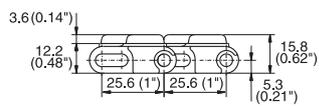
	M2540 Radius GripTop 1"						
	Open area	20 %					
	Open hinge	yes					
	Belt material		PP				
	GripTop material		TPE				
Rod material		POM	PA				
Nominal tensile strength F'_N straight run	N/m lb/ft	19000 1300	19000 1300				
Nominal tensile strength F'_N in curve	N lb	1000 225	1000 225				

HabasitLINK® Plastic Modular Belts

Series M2500 and M2600

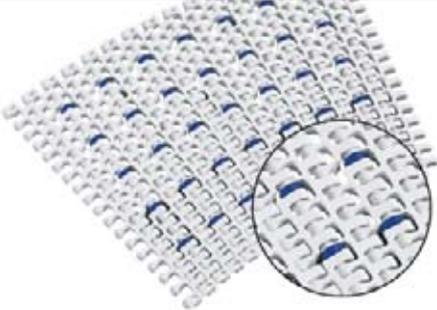
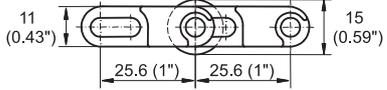
	M2540 Roller Top 1"					
	Open area	35 %				
	Open hinge	yes				
	Belt material		POM			
	Rod material		PA			
	Roller material		POM			
	Roller lateral spacing per row	mm inch	50 2			
	Roller dimension diameter / width	mm inch	Ø 15 / 5 Ø 0.59 / 0.2			
	Nominal tensile strength F'_N straight run	N/m lb/ft	22000 1507			
	Nominal tensile strength F_N in curve	N lb	1200 270			

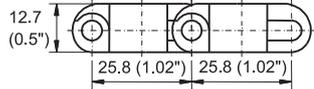
	M2544 Tight Radius 1"					
	Open area	38 %				
	Open hinge	yes				
	Belt material		PP	POM	POM+JM	
	Rod material		POM	PA		
	Nominal tensile strength F'_N straight run	N/m lb/ft	14000 959	14000 959	20000 1370	20000 1370
	Nominal tensile strength F_N in curve	N lb	600 135	600 135	1100 247	1100 247



Sprocket one-piece („open window“) (S)

Split sprocket (Z)

Type	Number of teeth	Diameter of pitch Ø d _p	
		mm	inch
S	7	59.4	2.3
S	8	66.7	2.6
S	10	82.5	3.3
S	12	98.6	3.9
S	15	122.7	4.8
S	16	130.8	5.2
S	18	146.9	5.8
S	20	163.0	6.4
Z	12	98.6	3.9
Z	18	146.9	5.8
Z	20	163.0	6.4

Series M2600

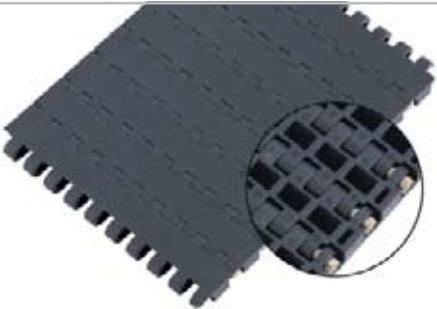
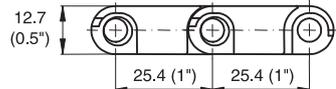
	M2620 Flat Top Heavy Duty 1" + ActivXchange							
	Open area	0 %						
	Open hinge	no						
	Belt material		PP	POM	PA	PBT +FR		
	Rod material		PP	PA	PBT	PA		
	Nominal tensile strength F'_N straight run	N/m lb/ft	24000 1644	26500 1815	45000 3083	35000 2397	45000 3083	23000 1575

HabasitLINK® Plastic Modular Belts

Series M2600 and M3800

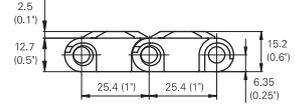

M2620 GripTop 1"					
Open area	0 %				
Open hinge	no				
Belt material		PP	POM		
GripTop material		TPE			
Rod material		PP	POM	PA	
Nominal tensile strength F'_N straight run	N/m lb/ft	23000 1575	24000 1644	33000 2260	

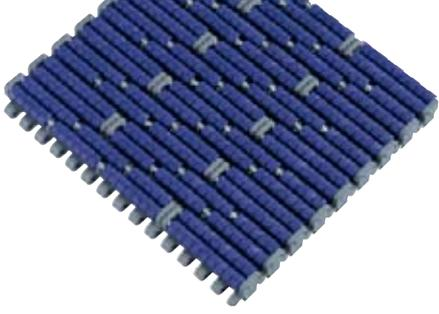

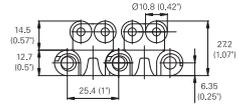
M2620 Roller Top - LBP 1"					
Open area	0 %				
Open hinge	no				
Belt material		POM			
Rod material		PBT	PA		
Nominal tensile strength F'_N straight run	N/m lb/ft	35000 2397	45000 3082		



Sprocket one-piece (solid) (S)

Split sprocket (Z)

Type	Number of teeth	Diameter of pitch $\varnothing d_p$	
		mm	inch
S	18	147.7	5.8
S	12	99.1	3.9
S	16	131.5	5.2
S	18	147.7	5.8
S	21	172.1	6.8
Z	12	99.1	3.9
Z	16	131.5	5.2
Z	18	147.7	5.8
Z	21	172.1	6.8



For the series M2600 the split sprocket is as **multihub** sprocket available. The robust patented design is consisting of 2 rim halves and 2 hub halves connected with 4 bolts with nuts.

Series M3800

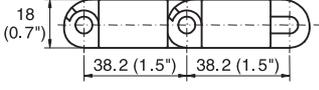

M3840 Radius Flush Grid 1.5"					
Open area	31 %				
Open hinge	yes				
Belt material		PP	POM		
Rod material		POM	PA		
Nominal tensile strength F'_N straight run	N/m lb/ft	23000 1575	23000 1575	32000 2192	
Nominal tensile strength F'_N in curve	N lb	2000 450	2000 450	2400 540	

HabasitLINK® Plastic Modular Belts

Series M3800 and M5100



M3843 Tight Radius 1.5"					
Open area	37 %				
Open hinge	yes				
Belt material		PP	POM		
Rod material		POM	PA		
Nominal tensile strength	N/m	20000	20000	29000	
F _N straight run	lb/ft	1370	1370	1986	
Nominal tensile strength	N	1800	1800	2250	
F _N in curve	lb	405	405	506	

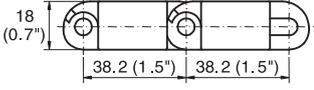

M3843 Tight Radius GripTop 1.5"					
Open area depends on pattern					
Open hinge	yes				
Belt material		PP	POM		
GripTop material		TPE			
Rod material		POM / Steel	PA / Steel		
Nominal tensile strength	N/m	20000	20000	29000	
F _N straight run	lb/ft	1370	1370	1986	
Nominal tensile strength	N	1800	1800	2250	
F _N in curve	lb	405	405	506	

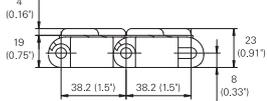



Type	Number of teeth	Diameter of pitch Ø d _p	
		mm	inch
S	8	101.9	4.0
S	12	150.0	5.9
S	6	198.2	7.8

Sprocket one-piece („open window“) (S)

Series M5100

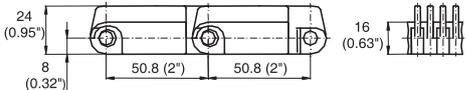

M5131 Raised Rib 2"					
Open area	36 %				
Open hinge	no				
Belt material		PP	PP +GR		
Rod material		PP			
Nominal tensile strength	N/m	32000	20000		
F _N straight run	lb/ft	2192	1370		



Type	Number of teeth	Diameter of pitch Ø d _p	
		mm	inch
S	16	261.5	10.3
S	10	165.2	6.5
S	12	197.2	7.8
S	13	213.2	8.4
S	16	261.5	10.3

Sprocket one-piece („open window“) (S)

Sprocket one-piece (solid) (S)

Features and Benefits

HabaCHAIN® Slat and Conveyor Chains

HabaCHAIN® is a high-quality range of new slat- and conveyor system chain products from Habasit. HabaCHAIN® products are suitable for a wide range of applications in beverage, bakeries, packaging and many other industries.



	Features	Benefits
	<ul style="list-style-type: none"> • High quality molding • Precision of molds • Superior quality materials 	<ul style="list-style-type: none"> → Excellent flat surface → High speed applications → Wear resistance → Less noise generation
	<ul style="list-style-type: none"> • Radius and straight transport • Robust design • Precision of molds 	<ul style="list-style-type: none"> → Flexible conveyor layouts → Wear resistance → Less noise generation
	<ul style="list-style-type: none"> • Suitable for linear and curve conveying • Grooved GripTop type 	<ul style="list-style-type: none"> → Flexible conveyor layouts, also 3Dimensional → Tight radius → No glazing effect → No slippage → Excellent rubber adhesion
	<ul style="list-style-type: none"> • Reduced back pressure (LBP) • Accumulation of products <p>(LBP = Low Back Pressure)</p>	<ul style="list-style-type: none"> → Less product damage → Less power consumption → Less noise generation
	<ul style="list-style-type: none"> • Interchangeable hubs • Also low noise gears available 	<ul style="list-style-type: none"> → Less stock positions / reduced stock → Allows a greater flexibility → 5 to 10 db less noise → Wear resistant

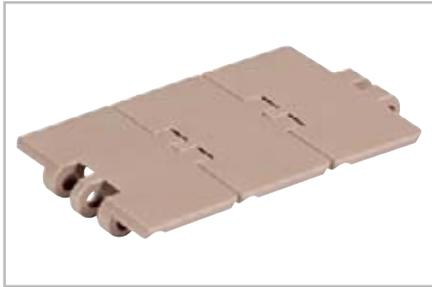

Slat Top 820 (Straight)

820 is a standard duty straight running slat top chain. Applications include packaging and bottling lines. Use 820 chain for side transfer with 880 series radius chain.



Slat Top 821 (Straight)

821 is a heavy duty straight running slat top chain. Applications include packaging and bottling lines. Use 821 series for side transfer with 882 series radius chain.



Slat Top 831 (Straight)

831 is a standard duty straight running slat top chain. Applications include packaging and bottling lines. Use 831 chain for side transfer with 879 series radius chain.



Slat Top 879T (Radius)

879T is a tabbed standard duty radius and straight running chain. Applications include general conveyance, packaging and empty container handling. Use 879T series for side transfer with 831 series straight chain.



Slat Top 770T (Radius)

Suitable for radius and straight conveying of various products and containers, for general light duty and bottling conveyors, with tight radius. Ideal for use with 820 series.



Slat Top 880T (Radius)

880T is a tabbed standard duty radius and straight running chain. Applications include general conveyance, packaging, and empty container handling. Use 880T series for side transfer with 820 series straight chain.



Slat Top 882T (Radius)

882T is a tabbed heavy duty radius and straight running chain. Applications include general conveyance, packaging and bottling. Use 882T series for side transfer with 821 series straight chain.



Slat Top 1061M (Radius)

Suitable for radius and straight conveying on magnetic systems with the modular belt type M2420 and M2470 Flat Top or in abrasive conditions especially glass applications. Thickness 8.7 mm.



GripTop chain

Slat Top 882TG (Radius) a tabbed heavy duty radius and straight running chain. Applications include general conveyance, packaging and bottling. The surface has rubber top inserts to allow for incline applications.



LBP 821 (Straight)

LBP 821 is a heavy duty straight running low-back-pressure chain. Applications include packaging lines in the accumulation areas especially around the palletizers.



LBP 882T (Radius)

LBP 882T is a tabbed heavy duty radius and straight running low-back-pressure chain. Applications include packaging lines in the accumulation areas especially around the palletizers.



Case chain 600 (Radius)

600 is a heavy duty 2.5" (63.50 mm) pitch radius and straight running closed top case conveyor chain. Applications include crate washers, empty keg lines and case conveyors.



Case chain 1400 (Radius)

1400 is a heavy duty 3.5" (82.5 mm) pitch radius and straight running open top case conveyor chain. Applications include crate washers, full keg lines and case conveyors.



Case chain 3200 (Straight)

3200 is a heavy duty 2" (50.8 mm) pitch straight running case conveyor chain. Applications include poultry conveyance and case conveyors.



Case chain 3210T (Radius)

3210T is a tabbed heavy duty 2" (50.8 mm) pitch radius and straight running case conveyor chain. Applications include poultry conveyance and case conveyors.



**Conveyor system chain 7100L
(Plastic Pin)**

7100L is a radius and straight running chain for light applications. Applications are in end-line on aluminum modular structure, including various packaging lines. The patented retaining system makes it simple to disassemble and join the chain with only a screwdriver.



Snap-on 1873+L4 (Radius)

1873+L4 tabbed is a heavy duty radius and straight running 4 finger style gripper chain. It is a two piece system that has a metallic 3/4" pitch 1873 roller chain with snap-on plastic top plates with a gripper. Applications include rinsers, elevators and lowerators.



Snap-on 1873+D1 (Radius)

1873+D1 is a tabbed heavy duty radius and straight running D style gripper chain. It is a two piece system that has a metallic 3/4" pitch 1873 roller chain with snap-on plastic top plates with a gripper. Applications include rinsers, elevators and lowerators.



Straight Track

Corner Track

Magnetic Track

Habasis offers a complete range of tracks for all chains with a large choice of materials to meet all your conveying applications. Our specialists will be pleased to analyze your requirements and propose the best solution for your needs.

Features and Benefits

HabaFLOW® Fabric Coated Belts

HabaFLOW® fabric coated TPU conveyor and processing belts combine many features that are supporting reliable and hygienic production processes. In the wrapping and packaging applications rubber coated belts ensure excellent performance and reliable feeding.

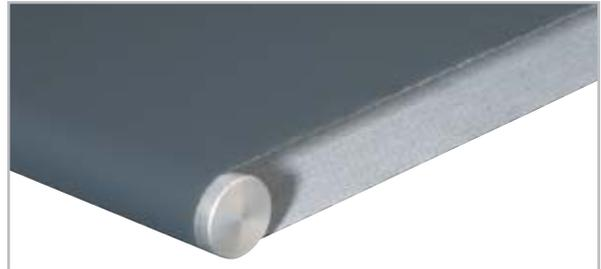

Features		Benefits										
	<ul style="list-style-type: none"> • A wide range of different surface types and belt strengths available <table border="1" data-bbox="571 835 815 1153"> <thead> <tr> <th colspan="2">Belt surface structures (selection only)</th> </tr> </thead> <tbody> <tr> <td>Blank / smooth</td> <td>Rough textile impression</td> </tr> <tr> <td>Waffle structure</td> <td>Elliptical structure</td> </tr> <tr> <td>Grip structure (rough top)</td> <td>Fish / herringbone structure</td> </tr> <tr> <td>Jink wave grip structure</td> <td>Quadrillé (quadrangular pattern)</td> </tr> </tbody> </table>	Belt surface structures (selection only)		Blank / smooth	Rough textile impression	Waffle structure	Elliptical structure	Grip structure (rough top)	Fish / herringbone structure	Jink wave grip structure	Quadrillé (quadrangular pattern)	<ul style="list-style-type: none"> → Appropriate selection for a specific application → Optimum adaptation to needs of the process (tailor-made solutions)
Belt surface structures (selection only)												
Blank / smooth	Rough textile impression											
Waffle structure	Elliptical structure											
Grip structure (rough top)	Fish / herringbone structure											
Jink wave grip structure	Quadrillé (quadrangular pattern)											
	<ul style="list-style-type: none"> • Longitudinal flexibility • High precision coating process 	<ul style="list-style-type: none"> → Belts can cope with small pulley diameters → Smooth and trouble-free product transfer → Closed, most homogeneous belt surface → Easy to clean 										
	<ul style="list-style-type: none"> • Wear resistant • Good temperature resistance 	<ul style="list-style-type: none"> → Abrasion resistant → Long service life → Suitable for wide temperature range 										
	<ul style="list-style-type: none"> • Rubber coated belts • Different rubber hardness and surface 	<ul style="list-style-type: none"> → Gentle, reliable treatment of packages → Different coefficient of friction → No marking on conveyed goods → Wear resistant → High grip, reliable feeding 										

www.habasit.com for in-depth information on products and applications as well as for detailed technical data and engineering tips.

Habasit - Solutions in motion

www.habasitlink.com
www.kvp-inc.com
www.habachain.com
www.habaflow.com

- FABRIC CONVEYOR BELTS
- PLASTIC MODULAR BELTS
- SPIRAL BELTS
- CHAINS
- POWER TRANSMISSION BELTS AND TAPES
- SEAMLESS BELTS
- TIMING BELTS
- FABRICATION TOOLS
- MOTORS, GEARS AND GEARMOTORS

www.habasitlink.com

Product overview

Products

- Straight belts
- Radius belts
- Spiral Belts
- Sprockets
- Accessories
- Modulclean
- Unique features
- Product Data Sheets
- More Habasit Products

Product overview

Straight belts

[Series 1100 \(Nominal pitch 12.7 mm \(0.5"\)\)](#)
[Series 1200 \(Nominal pitch 12.7 mm \(0.5"\)\)](#)

Single product description, dimensions

M1220 HighGrip-L 0.5"

Description
 • "HighGrip" non-slip compound
 • 15° open ribs
 • 10mm height
 • Ribbed 20mm (0.75")
 • Slat Top with grooved surface for high traction and easy grip reduction to start and stop
Available accessories
 • 15mm
Product Data Sheet
[M1220 HighGrip-L 0.5"](#)
[M1220 HighGrip-L 0.75"](#)
[M1220 HighGrip-L 1"](#)
[M1220 HighGrip-L 1.5"](#)
[M1220 HighGrip-L 2"](#)

- Product datasheet
- Corresponding sprocket information
- Corresponding flights and sideguards
- Services and guarantees

www.habachain.com

Product overview

Products

- Features & Benefits
- HabaCHAIN products
- Product Data Sheets
- Nomenclature
- Materials
- Profiles
- More Habasit Products

Product overview

HabaCHAIN Products

[Slat top chains](#)
[Slat Top R20 \(Skaght\)](#)
[Slat Top R21 \(Skaght\)](#)
[Slat Top](#)

Single product description, dimensions

Slat Top R21 (Radius)

Description
 R21 is a rubber-sheathed belt radius and shape covering chain. Applications include general conveying, packaging and engine component handling. Like R20, R21 is made for easy replacement. R21 covers sprockets that have been used for mechanical or chemical transfer systems.

Product datasheet

[Slat Top R21 \(Radius\)](#)

www.habaflow.com

Product overview

Products

- Belt Selection
- Conveyor Belts
- Modular Belts
- Spiral Belts
- Chains
- Power Transmission Belts and Tapes
- Round Belts
- Spindle Tapes
- Machine Tapes

General product overview

HabaFLOW Conveyor Belts

[Standard conveyor belts](#)
[Food conveyor and processing belts](#)
[Corrosion resistant belts](#)
[High force belts](#)

Product data
 → Selection of
 • product group
 • sub group
 • product
 or
Overview key data
 → Datasheet
Belt surfaces
 → Selection of core features

TPV food conveyor and processing belts

180° LOW Product Data Sheet FAW-SE

Product Designation	TPV food conveyor
Product Group	Food conveyor belt
Product Sub Group	Seamless conveyor belt
Multi-Industry Segments	Food, Meat, Poultry, Fish, Dairy, Chemical, Pharmaceutical
Belt Applications	Conveyor belt, Chain, Sprocket, Pulley, etc.
Special Features	Non-slip, wear-resistant, easy to clean
Material of Use/Composition	TPV, PU, etc.
Product Design (optional)	Standard, Custom
Product Construction/Design	Standard, Custom

Complementary Products: HabiPLAST® Profiles, Guides, Wear Strips

HabiPLAST® extruded profiles are the optimal and ideal complement for HabaCHAIN® and HabasitLINK® products.

HabiPLAST® extruded profiles are widely used in bottling and packaging as:

- Wear strips for table top chains
- Guide profiles
- Corner and straight ways for side HabaCHAIN® plastic chains

Habasit offers a full range of extruded guides and will assist you to develop the best solution for your application.

Examples for shape and alignment of HabiPLAST® profiles, guides and wear strips in beverage applications:

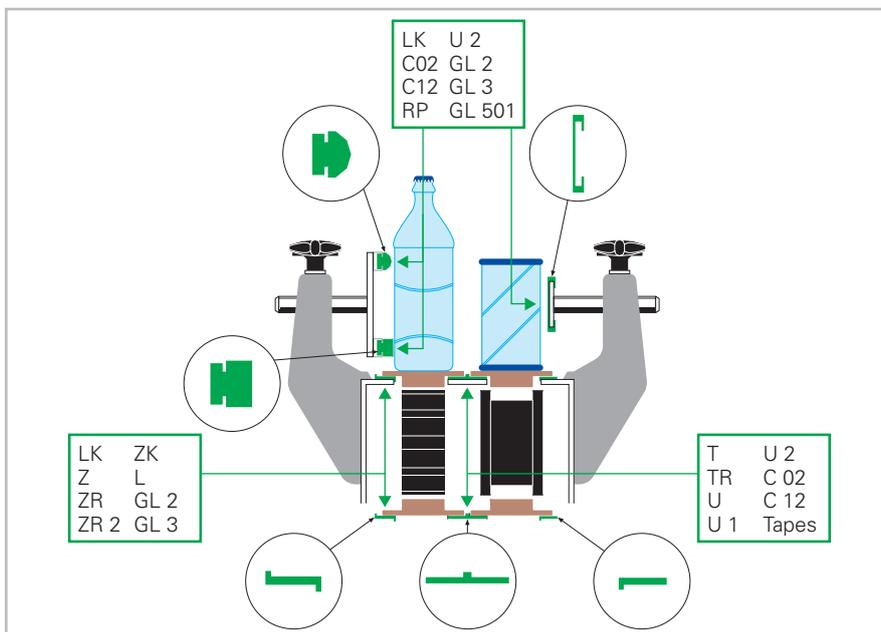

Features

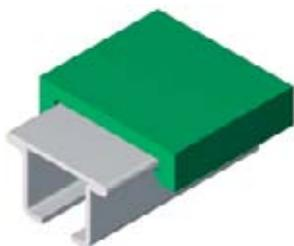

- **Great wear resistance**
- **Low coefficient of friction**
- **Low noise**
- **Good impact resistance, even at low temperature**
- **High chemical resistance**
- **Corrosion resistance**
- **Easy and quick assembling**

Extruded profiles (selection only)

For detailed information please consult the HabiPLAST® brochure (Media No. 4097) or visit website www.habasit.com

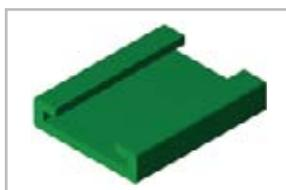
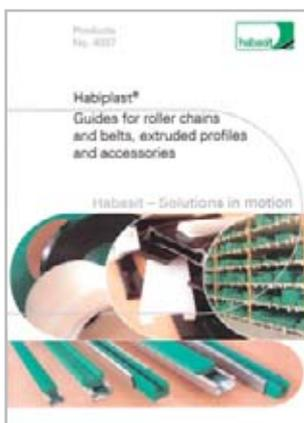

Profile C



Profile L

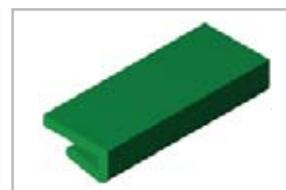

Profile LK



Profile T



Profile TR

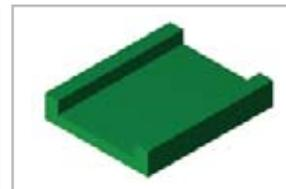

Profile U

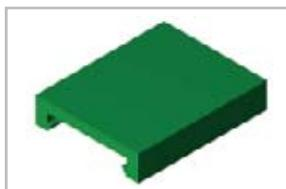

Profile U2

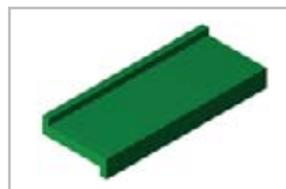

Profile Z



Profile ZK

Complementary Products: Motors, Gears, Gearmotors

Gear reducers, electronic speed variation & brake motors

Our partner Rossi Motoriduttori is one of Europe's largest groups for the production of gear reducers, gearmotors, electronic speed variation and brake motors.

Beverage processes use worm and right angle shaft gearmotors with double seals, reduced backlash and other accessories.

Rossi Motoriduttori products are used in:

Rinser-Filler-Capper machines, equipped with:

- Worm gear reducers (catalogue **A04**)
- Right angle shaft gear reducers (catalogue **L99**)
- Asynchronous three-phase motors (catalogue **TX06**)
- Inverter (catalogue **I03**)

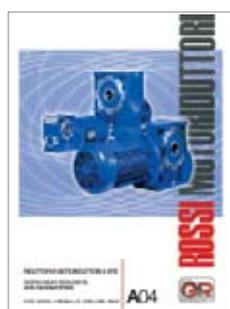

Washing Machines, equipped with:

- Worm gear reducers (catalogue **A04**)
- Right angle shaft gearmotors (catalogue **G05**)
- Inverter (catalogue **I03**)

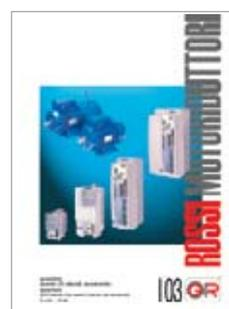
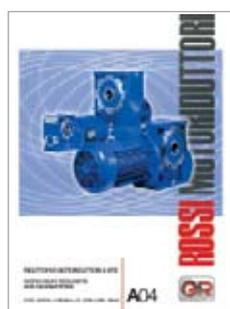

Conveyors group, equipped with:

- Worm gearmotors (catalogue **AS07 STANDARDFIT**)
- Coaxial gearmotors (catalogue **ES07 STANDARDFIT**)
- Integrated low backlash planetary servogearmotors (coaxial and right angle shafts), synchronous and asynchronous servomotors (catalogue **SM03**)
- Synchronous and asynchronous servogearmotors (with worm gear, coaxial, parallel and right angle shafts) (catalogue **SR04**)

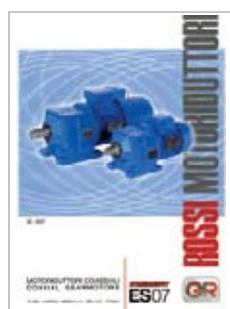

For further product information see www.rossi-group.com

Comprehensive services are central to Habasit’s solution approach. As committed partners to our customers, we are dedicated to sharing our knowledge and to providing full support.



Modular belt innovation center – Bottling test loop

The new modular belt innovation center with a bottling test loop (capacity 30,000 bph) allows verifying the modular belts and chains performance under application conditions. All typical bottles and containers e.g. aluminum cans, glass bottles, PET and steel containers can be tested in combination with HabasitLINK® modular belts and HabaCHAIN® products. Tests like:

- Functionality of accumulation, combiner / decombiner and 90° transfer
- Friction and abrasion tests
- Energy consumption
- Installation and maintenance
- Customer specific tests



Consulting and technical support

Habasit offers the best consulting and technical support on the belting market. Everything revolves around our customers. Each affiliate has its own belting experts. The Habasit team proudly provides the highest levels of support and top-quality products enjoyed by the global market for over 60 years.

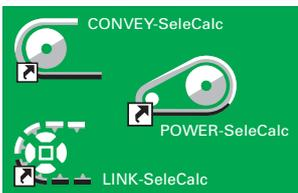

Assistance with belt selection and calculation

We will select and calculate the most suitable belt for your specific application. You may also do this yourself with our state-of-the-art Habasit selection and calculation program “SeleCalc”. To order this program free of charge, simply call your nearest Habasit partner or contact: info@habasit.com.



Fabrication, assembly and local installation services for quick reaction times

We make belts endless or assemble modular belts or chains, either at our own locations or on-site directly on your machine or system. Habasit operates 33 affiliated companies worldwide, each with its own inventory, fabrication, assembly and service facilities. Together with our representative offices and numerous qualified distributors, we can react quickly, competently and reliably to satisfy all your demands.



Customer training programs

Habasit offers training programs and support tools to ensure optimal use of our products and to prolong their lifecycles. Training on fabrication, installation, assembly, maintenance and belt repair takes place at Habasit sites or at your location.



Belt monitoring, inspections, analyses and process optimization proposals

We organize and handle belt maintenance, inspections, analyses and surveys for your locations. On request we will also work with you to develop optimization proposals, e.g. to achieve added value from the machinery or process output.



Design assistance for customized solutions

Habasit believes in partnership. Our engineering team will work closely with your engineers on joint design developments, preferably from a very early stage. We particularly recommend this for projects involving new technologies or large-scale modifications and adaptations.

At Habasit, we listen to our customers, innovate continuously and deliver reliable solutions to meet your every need.

Customers come first

At Habasit we understand that our success depends on your success. This is why we offer solutions, not just products; partnership, not just sales.

Since our foundation in 1946, Habasit has brought this understanding of customer needs to life every day and for every application. That's why we're the No. 1 in belting today. Worldwide.



Committed to innovation

Habasit is strongly committed to the continuous development of innovative, value-added solutions. Over 3% of our staff are dedicated exclusively to R&D, and our annual investment in this area exceeds 8% of turnover.



Certified for quality

We deliver the highest quality standards not only in our products and solutions, but also in our employees' daily work processes. Habasit AG is certified according to ISO 9001:2000.



Worldwide leading product range

Habasit offers the largest selection of belting, conveying, processing and complementary products in the industry. Our response to any request is nothing less than a specific, tailor-made solution.

A selection of our product ranges:



HabaFLOW®
Fabric based conveyor and processing belts

HabasitLINK®/KVP
Plastic modular belts

HabaDRIVE®
Power transmission belts



HabaSYNC®
Timing belts

HabaCHAIN®
Chains (slat and conveyor chains)

HabiPLAST®
Profiles
Guides
Wear strips



Machine tapes

Seamless belts

Round belts



Fabrication tools (joining tools)

Gear reducers
Gearmotors
Motion control

Electric motors

Worldwide support

Our extensive organization is ready to support you anywhere in the world. Engineering and emergency assistance, quotes and order status are just a phone call away. Wherever you are. Whenever you need us.

**For additional information please visit:
www.habasit.com**

Austria

Habasit GmbH, Wien
Phone: +43 1 690 66
www.habasit.at

Belgium

Habasit Belgium N.V., Zaventem
Phone: +32 2 725 04 30
www.habasit.be

Canada

Habasit Canada Ltd., Oakville
Phone: +1 905 827 4131
www.habasit.ca

China

Habasit East Asia Ltd., Hong Kong
Phone: +852 2145 01 50
www.habasit.com.hk

Habasit (Shanghai) Co., Ltd.
Shanghai

Phone: +8621 5488 1228
Phone: +8621 5488 1218
www.habasit.com.hk

Czech Republic

Habasit Bohemia spol. s.r.o., Brno
Phone: +4205 41 421 651
www.habasit.cz

France

Habasit France S.A.S., Mulhouse
Phone: +33 389 33 89 03
www.habasit.fr

Germany

Habasit Rossi GmbH,
Eppertshausen
Phone: +49 6071 969 0
www.habasitrossi.de

Hungary

Habasit Hungária Kft., Esztergom
Phone: +36 33 510 610
www.habasit.hu

India

Habasit-Iakoka Pvt. Ltd., Coimbatore
Phone: +91 422 262 78 79
www.habasitiakoka.com

Italy

Habasit Italiana SpA
Customer Care:
Phone: 199 199 333
For int. calls: +39 0438 911444
www.habasit.it

Japan

Habasit Nippon Co. Ltd., Yokohama
Phone: +81 45 476 03 71
www.habasit.co.jp

Latvia

Habasit Baltic SIA, Daugavpils
Phone: +371 54 074 88
www.habasit.lv

Netherlands

Habasit Netherlands BV, Nijkerk
Phone: +31 33 24 72 030
www.habasit.nl

New Zealand

Habasit Australasia Ltd., Hornby
Phone: +64 3348 5600
www.habasit.co.nz

Norway

Habasit Norge A/S, Oslo
Phone: +47 81 55 84 58
www.habasit.no

Poland

Habasit Polska Sp. zo.o.,
Dąbrowa Górnicza,
Phone: +48 32 639 02 40
www.habasit.pl

Romania

Habasit Import/Export Romania SRL,
Bucuresti, Phone: +40 21 323 95 65
www.habasit.ro

Russia

OOO Habasit Ltd., St. Petersburg
Phone: +7 812 365 64 62
www.habasit.ru

Singapore

Habasit Far East Pte. Ltd., Singapore
Phone: +65 6862 55 66
www.habasit.com.sg

Spain

Habasit Hispanica S.A.,
Barberà del Vallès
Phone: +34 93 719 19 12
www.habasit.es

Sweden

Habasit AB, Hindas
Phone: +46 301 226 00
www.habasit.se

Switzerland

Habasit Schweiz, Reinach
Phone: +41 61 715 15 75
www.habasit.ch

Taiwan

Habasit Rossi (Taiwan) Ltd.
Taipei Hsien
Phone: +886 2 2267 0538
www.habasit.com.tw

Turkey

Habasit Kayis San. Ve Tic. Ltd. Sti.
Yenibosna - Bahcelievler - Istanbul
Phone: +90-212-654 94 04
www.habasit.it

Ukraine

Habasit Ukraina, Vinnica
Phone: +38 0432 58 47 35
www.habasit.ua

United Kingdom and Ireland

Habasit Rossi (UK) Ltd., Silsden
Phone: + 44 870 835 9555
www.habasitrossi.co.uk

USA

Habasit America
Suwanee, Georgia
Phone: +1 800-458-6431
www.habasitamerica.com

Habasit America (HABT)
Middletown, Connecticut
Phone: +1 860 632 2211
www.habasitamerica.com

Rossi Motoriduttori is one of Europe's largest industry groups for the production and sale of gear reducers, gearmotors, inverters, standard and brake motors.

ROSSI MOTORIDUTTORI

Via Emilia Ovest 915/A
41100 Modena – Italy
Phone: +39 059 33 02 88
Fax: +39 059 82 77 74
www.rossi-group.com
info@rossi-group.com

Headquarters

Habasit AG
Römerstrasse 1
CH-4153 Reinach, Switzerland
Phone +41 61 715 15 15
Fax +41 61 715 15 55
E-mail info@habasit.com
www.habasit.com

Registered trademarks
Copyright Habasit AG
Subject to alterations
Printed in Switzerland
Publication data:
2062BRO.BEV-en0208HQR

Modular belt material description

Material	Code	Property	Food approval ¹⁾	Density g/cm ³	Temperature range	Habasit colors
Polypropylene	PP	Thermoplastic material with good cost/performance relation (material for most of the common conveying applications). Excellent chemical resistance to acids and alkalines. High impacts below 10 °C (50 °F) must be avoided.	EU FDA	0.9	+5 °C to +105 °C +40 °F to +220 °F	white gray blue
Polyoxymethylene (Acetal)	POM (AC)	Thermoplastic material with high strength and low coefficient of friction. Impact and cut resistant surface. Suitable for heavy conveying applications and low temperatures. Good chemical resistance to oil and alkalines, but not suitable for long-term contact with high concentration of acids and chlorine. For HabaCHAIN® slat and conveyor chains various types are available like LF (Low-Friction POM) and PT (Extra Low-Friction POM).	EU FDA	1.42	wet conditions: -40 °C to +60 °C -40 °F to +140 °F dry conditions: -40 °C to +90 °C -40 °F to +195 °F	blue white dark gray
Electrically conductive Polyoxymethylene (Acetal)	POM (AC) Code addition +EC	Thermoplastic material with a low electrical surface and volume resistance. Electrical surface resistivity ps below 50'000 Ohm/sq (DIN/EN 1637). Material has a high strength and low coefficient of friction. Suitable for heavy conveying applications and low temperatures. Technical data like standard POM.		1.42	dry conditions: -40 °C to +90 °C -40 °F to +195 °F	black
Polyamide reinforced	PA Code addition +GF	Reinforced thermoplastic material with high strength. Suitable for heavy conveying applications at dry conditions and elevated temperatures. Material is specially modified to keep its good properties stable over a long time at elevated temperatures. Flammability UL94 HB.	EU FDA	1.41	wet conditions: not recommended dry conditions: 0 °C to +145 °C (short-term +175°C) +32 °F to +293 °F (short-term +347 °F)	dark brown
Super High Temperature	ST	Reinforced thermoplastic material with very good heat and hydrolysis resistance. Suitable for light conveying applications at elevated temperatures. Material is specially modified to keep its good properties stable over a long time at elevated temperatures. Flammability UL94 V0, ISO-340.	EU FDA	1.65	wet conditions: on request dry conditions: 0 °C to +200 °C (short-term +240 °C) +32 °F to +392 °F (short-term +464 °F)	beige or dark brown

¹⁾ For detailed food approval, please contact Habasit

Recommendations

The listed selection tables contain standard materials and **are recommendations only**. Due to the complexity of various processes, technical requirements and decisive external influences (e.g. shape and size of transported goods, process speed, steps of treatment / handling, environment or process temperature, humidity, chemicals, etc.) other belt types or materials may be used as well. For details or further information please contact your local Habasit partner.

Belt Selection Table for Beverage Applications (Selection only)

Fold up poster contents

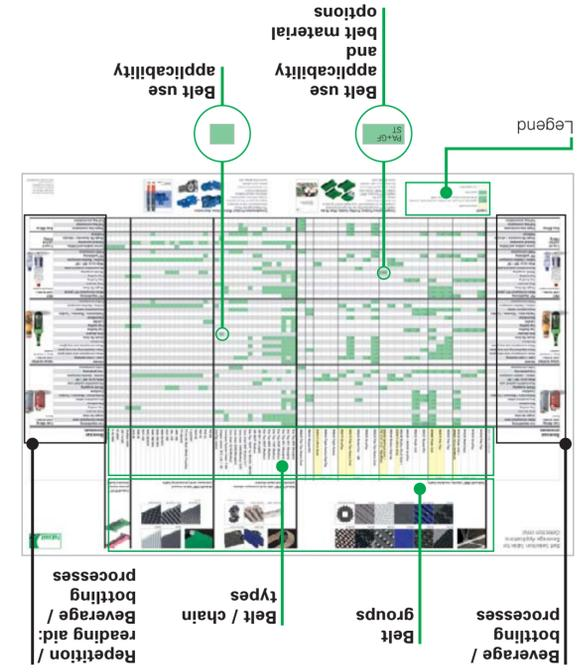

Inner fold: HabasitLINK® plastic modular belt material description